

# Chemical and Biological Contamination Avoidance

## Table of Contents

PREFACE ...	v
INTRODUCTION ...	vi
CHAPTER 1 Vulnerability Analysis ...	1-0
The IPB Process ...	1-0
CB Threat Status ...	1-2
Chemical Vulnerability Analysis ...	1-4
Biological Vulnerability Analysis ...	1-6
Vulnerability Reduction ...	1-6
Active Measures ...	1-6
Passive Measures ...	1-6
CHAPTER 2 NBC Warning and Reporting System ...	2-1
Standard NBC Reports ...	2-1
NBC 1 Report ...	2-1
Initial Use Report ...	2-2
NBC 2 Report ...	2-3
NBC 3 Report ...	2-3
NBC 4 Report ...	2-3
NBC 5 Report ...	2-3
NBC 6 Report ...	2-4
Managing the NBC Warning and Reporting System ...	2-4
Collecting CB Information ...	2-4
Monitoring, Survey and Reconnaissance Data ...	2-4
Evaluating CB Information ...	2-4

**DISTRIBUTION RESTRICTION:** Distribution is authorized to US government agencies only to protect technical or operational information from automatic dissemination under the International Exchange Program or by other means. This determination was made 9 January 1992. Other requests for this document will be referred to Commandant, US Army Chemical School, ATZN-CM-NF, Fort McClellan, AL 36205-5020.

**DESTRUCTION NOTICE:** Destroy by any method that will prevent disclosure of contents or reconstruction of the document.

\* This publication supercedes the chemical and biological portions of FM 3-3, 30 September 1986.

- Transmitting CB Information ... 2-5
- Unit Procedures ... 2-4
- NBCC Procedures ... 2-4
- Unit Level ... 2-5
- Battalion Level ... 2-5
- Brigade/Task Force Level ... 2-6
- NBCC Level ... 2-6
- Chemical Attack Warning (CHEMWARN) ... 2-6
- Automated Nuclear, Biological, and Chemical Information System (ANBACIS) ... 2-6

**CHAPTER 3 Chemical Agents ... 3-0**

- Types of Chemical Agents ... 3-0
  - Persistent ... 3-0
  - Nonpersistent ... 3-0
- Detection and Identification ... 3-1
  - Automatic Chemical Agent Alarm (ACAA) ... 3-1
  - Chemical Agent Monitor (CAM) ... 3-2
  - Individual Chemical Agent Detector (ICAD) ... 3-4
  - ABC-M8 Chemical Agent Detection Paper ... 3-4
  - M9 Chemical Agent Detection Paper ... 3-5
  - M256 Series Chemical Agent Detector Kit ... 3-5
  - M272 Water Test Kit ... 3-5
  - M93 Recon Operations ... 3-6 
  - M21 Remote Sensing Chemical Agent Alarm (RASCAL) 3-15 Reporting ... 3-6
  - Reporting ... 3-7
  - Data Evaluation ... 3-7
  - Chemical Downwind Message (CDM) ... 3-8
  - Preparing the Chemical Downwind Message ... 3-9
  - Atmospheric Stability Charts ... 3-10
  - Temperature Gradients ... 3-10
  - Simplified Hazard Prediction ... 3-11
  - Duration of Agent ... 3-12
  - Chemical Downwind Hazard Prediction ... 3-12
  - Type of Attack ... 3-12
    - Air-Contaminating Agents - Type A ... 3-12
    - Ground-Contaminating Agents - Type B ... 3-12
  - Plotting the Downwind Hazard - Type A ... 3-12
  - Plotting the Downwind Hazard - Type B ... 3-17
  - Adjusted Hazard Prediction ... 3-20
  - Time of Arrival ... 3-21
  - Chemical Hazard Prediction at Sea ... 3-21
  - General Procedures ... 3-22
  - Naval Chemical Downwind Message (NAV CDM) ... 3-22
  - Naval Chemical Downwind Hazard Prediction Simplified Procedure ... 3-23
  - Determination of the Hazard Area ... 3-23
  - Naval Detailed Chemical Downwind Hazard Prediction ... 3-23
  - Determination of the Downwind Hazard Area ... 3-26

Chemical Prediction Data Sheet ... 3-26  
 Avoidance Procedures ... 3-28  
 Vehicle Operations ... 3-28  
 Helicopter Operations ... 3-29



#### **CHAPTER 4 Biological Agents ... 4-0**

Pathogens ... 4-0  
 Bacteria ... 4-0  
 Viruses ... 4-0  
 Rickettsia ... 4-0  
 Toxins ... 4-0  
 Characteristics of BW Agents - Delayed Effects ... 4-1  
 Large Area Coverage ... 4-13  
 Control ... 4-1  
 Skin Penetration ... 4-1  
 Influence of Weather Conditions on the Effectiveness of Biological Attack ... 4-1  
 Sunlight ... 4-1  
 Humidity ... 4-1  
 Wind ... 4-2  
 Temperature Gradient ... 4-2  
 Precipitation and Temperature ... 4-2  
 Windows of Vulnerability ... 4-2  
 Persistency of Biological Agents/Hazard ... 4-2  
 Use of Biological Agents Against U.S. Forces ... 4-3  
 Using Intelligence Sources ... 4-4  
 Recognizing a Pattern of Employment ... 4-4  
 Recognizing Distinguishing Symptoms, Signs, and Effects ... 4-4  
 Dissemination Techniques and Avoidance Procedures ... 4-4  
 Aerosol Dissemination Procedures ... 4-5  
 Zones of Contamination ... 4-6  
 Aerosol Avoidance Procedures ... 4-7  
 Vector Dissemination Procedures ... 4-8  
 Vector Avoidance Procedures ... 4-8  
 Covert Dissemination and Avoidance Procedures ... 4-9  
 Warning and Reporting ... 4-9  
 Principles of Hazard Prediction ... 4-10  
 Simplified Downwind Hazard Prediction for Biological Agents ... 4-13  
 Hazard Prediction ... 4-14  
 Sampling ... 4-16  
 Evacuation of Biological Samples ... 4-19

#### **CHAPTER 5 CB Reconnaissance, Monitoring, and Survey: Planning, Conducting, Recording and Reporting ... 5-1**

Location of Chemical Agents ... 5-1  
 Reconnaissance ... 5-1  
 Procedures ... 5-1

- Recording and Reporting Recon Information ... **5-2**
- Monitoring ... **5-2**
- Surveys ... **5-2**
- Techniques ... **5-4**
- Recording and Reporting Procedures ... **5-5**
- Operational Aspects ... **5-5**
- Point Surveillance, Area Surveillance, and Reconnaissance ... **5-6**
- Contamination Marking ... **5-6**
- Standard Signs ... **5-7**
- Marking Contaminated Material ... **5-7**
- Biological Sampling ... **5-7**
- Types of Samples ... **5-11**
- Liquids ... **5-11**
- Vegetation ... **5-11**
- Soil ... **5-11**
- Ordnance ... **5-11**
- Priorities ... **5-11**
- Quantities ... **5-11**
- Sampling Equipment ... **5-12**
- Commercial Air Samplers ... **5-12**
- Employment ... **5-13**
- Modular Chemical and Biological Agent Sampling Kit (CBASK) ... **5-13**
- Where to Take Samples ... **5-13**
- How to Sample ... **5-14**
- Gases-Unbagged Pack ... **5-14**
- Liquids-Unmarked Packs ... **5-14**
- Solids-Unmarked Packs ... **5-14**
- General Packaging Procedures ... **5-15**
- Sampling ... **5-15**
- Witness Interview ... **5-16**
- Acquisition Reporting ... **5-16**
- Evacuation of Samples ... **5-17**
- CHAPTER 6 Civilian Chemical Hazards ... 6-0**
- APPENDIX A CB Operational Situation Guidelines for Contamination Avoidance ... A-1**
- APPENDIX B Biological Agents and Toxins ... B-0**
  - Country Codes for Sample Reports ... **B-6**
- APPENDIX C Reproducible Forms ... C-1**
- GLOSSARY ... Glossary-1**
- REFERENCES ... References-0**
- INDEX ... Index-1**

**Change 1**

HEADQUARTERS  
DEPARTMENT OF THE ARMY  
US MARINE CORPS

Washington, DC, 29 September 1994

**Chemical and Biological Contamination Avoidance**

FM 3-3/FMFM 11-17, 16 November 1992, is changed as follows:

1. New or changed material is indicate by a BAR (#).
2. Distribution restriction statement identified on this change replaces the one shown on basic publication dated 16 November 1992.
3. Remove old pages and insert new pages as indicated below:
4. File this transmittal sheet in front of the publication.

Remove Old Pages

1-5 thru 1-6  
2-1 thru 2-2  
2-3 thru 2-4  
3-3 thru 3-4  
3-5 thru 3-6  
3-9 thru 3-10  
3-11 thru 3-12  
3-13 thru 3-14  
3-15 thru 3-16  
3-17 thru 3-18  
3-19 thru 3-20  
3-21 thru 3-22  
4-1 thru 4-2  
4-13 thru 4-14  
4-15 thru 4-16  
5-3 thru 5-4  
5-11 thru 5-12  
5-17 thru 6-0  
A-15 thru B-0  
B-1 thru B-2  
Glossary-1 thru Ref-0  
Ref-1 thru Index-0

Insert New Pages

1-5 thru 1-6  
2-1 thru 2-2  
2-3 thru 2-4  
3-3 thru 3-4  
3-5 thru 3-6  
3-9 thru 3-10  
3-11 thru 3-12  
3-13 thru 3-14  
3-15 thru 3-16  
3-17 thru 3-18  
3-19 thru 3-20  
3-21 thru 3-22  
4-1 thru 4-2  
4-13 thru 4-14  
4-15 thru 4-16  
5-3 thru 5-4  
5-11 thru 5-12  
5-17 thru 6-0  
A-15 thru B-0  
B-1 thru B-2  
Glossary-1 thru Ref-0  
Ref-1 thru Index-0

DISTRIBUTION RESTRICTION: Distribution is authorized to US government agencies only to protect technical or operational information from automatic dissemination under the International Exchange Program or by other means. This determination was made 2 May 1994. Other requests for this document will be referred to Commandant, US Army Chemical School, ATTN: ATZN-CM-FNB, Fort McClellan, AL 36205-5020.

DESTRUCTION NOTICE: Destroy by any method that will prevent disclosure of contents or reconstruction of the document.  
MARINE CORPS PCN: 13971190001

By Order of the Secretary of the Army:

Official:

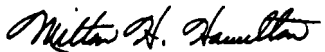
  
MILTON H. HAMILTON  
*Administrative Assistant to the  
Secretary of the Army*  
07244

GORDON R. SULLIVAN  
*General, United States Army  
Chief of Staff*

By Order of the Marine Corps:

**CARL E. MUNDY, JR.**  
**Commandant**  
**United States Marine Corps**

**DISTRIBUTION:**

*Active Army, USAR, and ARNG:* To be distributed in accordance with DA Form 12-11 E, Requirements for FM 3-3, Chemical and Biological Contamination Avoidance, (Qtr rqr block 3829).

# Preface

The mission of the Chemical Corps is to prepare the Army to survive and win in a Chemical and Biological (CB) warfare environment by -

- Developing doctrine, organizations, training products, and equipment for CB defense, chemical retaliation, and smoke and flame operations.
- Minimizing the impact of CB weapons through contamination avoidance, protection, and decontamination.
- Employing smoke.
- Employing flame.

This manual is one of five that explains the fundamentals of NBC defense:

- FM 3-3, Chemical and Biological Contamination Avoidance.
- FM 3-3-1, Nuclear Contamination Avoidance.
- FM 3-4, NBC Protection.
- FM 3-5, NBC Decontamination.
- FM 3-7, NBC Handbook

A general overview of these fundamentals is given in FM 3-100, NBC Operations. This manual, FM 3-3, defines and clarifies the entire process of CB contamination avoidance. Another manual, FM 3-3-1, outlines contamination avoidance procedures for nuclear operations. This manual has limited distribution specially for separate brigades, division, and corps level NBC Control Centers. Unless otherwise stated, whenever the masculine gender is used, both men and women are included.

FM 3-3 details the NBC Warning and Reporting System, how to locate and identify CB contamination, and how to operate in and around NBC contamination. This manual is designed and intended to be an

easy-to-read, step-by-step manual depicting the manual method of calculating CB contamination avoidance procedures for chemical officers and NCOs. However, subject matter discussed in Chapters 1 and 2 and Appendices A and C are of general use for all branches and MOS.

Chapter 1 defines the CB Threat, how to reduce unit vulnerability, and implements STANAG 2984, graduated levels of NBC Threat and minimum protection.

Chapter 2 defines how we warn our troops of an enemy CB attack and how we warn of a friendly chemical attack.

Chapters 3, 4, 5, and 6 detail procedures for detecting, identifying, evaluating and plotting hazards while operating in an CB environment. These chapters are essential for battalion, brigade, and division chemical personnel.

Appendix A provides operational situation guidelines for the principles of contamination avoidance in the form of a checklist.

Appendix B provides supplemental information on biological agents and a list of country codes used in processing biological samples.

Chemical personnel must be familiar with and be able to apply the information in this manual.

The proponent of this manual is the U.S. Army Chemical School. Submit changes for improving this publication on DA Form 2028 (Recommended Changes to Publications and Blank Forms) and forward to:

Commandant  
 US ACML&MPCEN&FM  
 ATTN: ATZN-CM-FNB  
 5th Avenue, Bldg 1081  
 Fort McClellan, AL 36205-5020.

# Introduction

Contamination avoidance is the best defense against enemy use of chemical and biological (CB) weapons. Avoidance reduces the risk of being targeted by CB agents and minimizes the effects of CB contamination hazards. Knowing where contamination exists or how long the hazard may persist is essential to avoiding the hazard. Enemy use of CB weapons make battlefield operations more difficult and time consuming. Combat, combat support, and combat service support operations may be more difficult to perform in a CB environment. Tasks/missions may take more time, but they require prior training in Mission Oriented Protective Posture (MOPP) gear because of the problems created by CB contamination. CB attacks may cause casualties, materiel losses, and creation of many obstacles. Training will reduce the problems caused by CB attacks on the unit. Units must locate clean areas as well as locate contamination in an CB environment. Contaminated units will have to perform decontamination (decon) operations.

To survive and accomplish the mission, individuals and units must take precautions to avoid or minimize effects of initial and residual CB hazards. The threat of contamination may force individuals and units into MOPP gear or into collective protection. Wearing MOPP gear results in heat buildup and degrades individual performance. Using collective protection requires special procedures that are time consuming. See FM 3-4 for information on what measures or steps an enemy CB attack may affect friendly forces. FM 3-3 outlines how to anticipate an enemy CB attack and minimize the effects on friendly forces.

## Contamination Avoidance

There are four steps to contamination avoidance: implement passive defensive measures, warn and report CB attacks, locate, identify, track and predict CB hazards, and limit exposure to CB hazards. If the mission permits, avoiding CB hazards completely is the best course of action. This is not always possible. The mission may force you to occupy or cross a contaminated area. This manual outlines procedures to use when working or training to work in a contaminated environment. Using these procedures, which are summarized by the four steps of contamination avoidance, units can minimize performance degradation.

## Implement Passive Defensive Measures

Passive defensive measures are those measures taken to reduce the probability of being hit by a CB attack or, if hit, to reduce the effects of the attack. Operational security measures such as good communication procedures, light discipline, and good camouflage reduce the chances of a unit being targeted. Dispersion, hardening of positions and equipment, and using overhead cover reduces the effectiveness of an attack. Passive measures are discussed in more detail in Chapter 1.

## Warn and Report

Once a CB attack has occurred everyone who might be affected by the hazard must be warned. This gives units time to protect themselves against a possible hazard. The NBC Warning and Reporting System (NBCWRS) is used for warning and reporting CB hazards. These messages and their use are standardized and kept simple so they can be passed rapidly and be easily understood. The NBCWRS is discussed in Chapter 2. The Automated NBC Information System (ANBACIS) will assist in speeding this process.

## Locate and Identify, Track and Predict

### NBC Hazards

By locating, identifying, tracking, and/or predicting CB hazards, commanders can make informed decisions for operating in or around NBC hazards. Planning CB reconnaissance is discussed in Chapter 5. Tactics and techniques of CB reconnaissance are contained in FM 3-19, NBC Reconnaissance. Techniques for predicting CB hazards are given in Chapters 3 and 4. A portion of ANBACIS provides for the automatic calculation of hazard areas due to chemical or biological weapons using or creating all NBC 1 through NBC 5 Reports.

## Limit Exposure

If operation in a contaminated area is necessary, take steps to limit the amount of troop exposure. Chapters 3 and 4 discuss crossing contaminated areas. FM 3-4, NBC Protection, gives guidance on protective measures



for such crossings and FM 3-19, NBC Reconnaissance, describes the techniques for finding the best crossing route.

## Protection and Decontamination

If a unit is unable to avoid CB hazards, the individual soldier and unit must take protective measures. Actions that minimize equipment losses and limit the spread of contamination are discussed in this manual. Measures taken to aid in protection are covered in FM 3-4.

If a unit is unable to avoid contamination, then some form of decon will be necessary. Decon reduces the immediate CB hazard. It may allow troops to reduce their MOPP level and operate in a contamination-free environment. Decon is discussed in FM 3-5.

## Tactical Considerations

If CB weapons are used, individual and collective protective measures must be taken. Time-consuming and manpower-intensive tasks such as CB reporting, and chemical recon, surveys, and decon may be necessary.

## Mission

CB contamination forces the commander to reconsider how best to accomplish the mission with the available resources. The commander has five options. In order of preference, these are:

First, do the mission in a clean area. The commander must decide whether the mission can be accomplished while staying out of contaminated areas.

Second, do the mission in a contaminated area using a higher MOPP level, but take more time.

Third, do the mission in a contaminated area using a higher MOPP level, and use more soldiers or equipment.

Fourth, delay the mission until the contamination has weathered.

Fifth, do the mission in the same amount of time with the same number of soldiers, but take a greater risk by using a MOPP level that does not provide maximum protection.

## Enemy

In addition to trying to determine what the enemy plans to do, the commander also must determine how and where the enemy is most likely to use CB weapons. For example, if the enemy is attacking, expect biological agents (pathogens) to be used as early as one to two weeks prior to the attack. Expect nonpersistent chemical agents and biological toxins to be used against front-line units, and persistent agents and toxins to be used on

combat service support units and to protect the flanks of attacking maneuver units by contaminating the terrain to restrict movement.

## Terrain

Terrain modifies CB weapons' coverage. Hills disrupt the normal dispersion of chemical and biological agents.

## Troops

The physical condition of troops is very important. Tactical decisions must consider how troops will be affected. CB weapons and wearing MOPP 4 impacts psychologically and physiologically on troops.

## Time

Tasks may take longer in a CB environment. Routine tasks may be more difficult when troops are in MOPP gear if they have not been trained to do them. Adding CB requirements to conventional recon adds time to the mission. Decon operations are also time-consuming.

Anticipating the timing of CB attacks is important. Chemical and biological attacks are most likely to occur during the night and early morning or evening hours.

## Training

Commanders must understand the importance that training has on a soldier's and unit's ability to complete the mission. When troops are well trained, they can survive and fight on a contaminated battlefield. Poorly trained troops may not be able to recognize a CB attack, and be less conditioned to wearing MOPP gear for extended periods. Well-trained troops can do their jobs, while in an CB environment. They know tasks take longer while wearing MOPP gear, but are able to adjust their procedures and/or work rate accordingly.

# Chapter 1

## Vulnerability Analysis

The focus of this field manual is Chemical and Biological (CB) Contamination Avoidance. Like most concepts in the Army, contamination avoidance is a process. This process involves—

- Assessing the threat facing friendly forces.
- Identifying whether friendly units are a target.
- Understanding the field behavior of CB contamination.
- Locating CB hazards on the battlefield.

By identifying and locating CB hazards on the battlefield, units will be able to either avoid the hazard or implement those protective procedures outlined in FM 3-4 to minimize the effects of the hazard on unit performance.

However, before we begin the discussion of contamination avoidance, we must first discuss two critical, often overlooked, aspects of successful operations on the contaminated battlefield. These two aspects are CB threat assessment and vulnerability analysis. Both are described in this chapter.

The CB threat now and in the future will be global from low to high intensity. Terrorists may be encountered at any level of conflict. The proliferation of CB capable nations in all contingency regions and the availability of toxic CB materials increase the likelihood of US forces being direct or inadvertent targets of attack. These attacks may range from limited use in terrorist actions to planned targeting in support of military operations.

As Chapter 1 of FM 3-100 points out, CB proliferation is increasing. Deploying US forces must be capable of accurately assessing the CB threat imposed by the opposing force and be capable of addressing unit vulnerability to attack. Chapter 2 in FM 3-100 describes in detail how CB agents may be used and how their use may shape the battle.

When planning operations, commanders must consider the potential effects of CB weapons on personnel and equipment. In conventional operations, concentration of forces increases the chance for success, but this same concentration increases the effects of CB attacks and the likelihood of their occurrence. Consider the timing of force concentration to reduce the effects from a CB attack.

To assess a unit's vulnerability to CB attack, the commander determines how well protected the unit is

and the type and size of weapon likely to be used against it. The commander then weighs various courses of action and determines which presents an acceptable risk to allow accomplishment of the mission. This whole process starts with the Intelligence Preparation of the Battlefield (IPB) with an initial assessment of the CB threat.

### The IPB Process

The IPB process is a staff tool that helps identify and answer the commander's priority intelligence requirements (PIR), it's part of the operational planning that is necessary for battle management.

IPB is initiated and coordinated by the S2 and used to predict battlefield events and synchronize courses of action. IPB is designed to reduce the commander's uncertainties concerning weather, enemy, and terrain for a specific geographic area in a graphic format. It enables the commander to see the battlefield: where friendly and enemy forces can move, shoot, and communicate where critical areas lie; and where enemy forces (and his own) are most vulnerable. IPB guides the S2 in determining where and when to employ collection assets to detect or deny enemy activities. These assets, working collectively, fulfill intelligence requirements and answer the PIR. IPB is the key for preparing for battle. It analyzes the intelligence data base in detail to determine the impact of enemy, weather, and terrain on the operation and presents this information graphically. It is a continuous process which supports planning and execution for all operations. IPB consists of a systematic five-function process involving—

- Evaluation of the battlefield (areas of operation and influence).
- Terrain analysis.
- Weather analysis.
- Threat evaluation.
- Threat integration.

On the battlefield, units will have incomplete intelligence concerning enemy chemical and biological capabilities and/or intentions. However, commanders, must ensure that the IPB becomes an integrated process through which key members of the staff contribute. IPB is a process involving intelligence and operations personnel. It must also be integrated with input from chemical officers.

Chemical officers and NCOs, in coordination with the S2/3, must address CB warfare during all phases of the battle. This is accomplished only by direct participation in the IPB process. Working with the S2, the chemical staff should—

- Template potential chemical targets or areas of contamination.
- Designate templated areas that effect the scheme of maneuver as named areas of interest (NAI).
- Include NAIs into the collection plan and identify indicators.
- Include designated NAIs into the reconnaissance and surveillance plan (R&S) and designate responsibility for confirming or denying the template.

Using the IPB process, the chemical officer/NCO provides the commander updates on the CB situation, as well as flame and smoke operations.

Based on the time periods of interest, the chemical staff will provide the battle commander with—

- Detailed information on enemy CB capabilities based on the type of units and weapons the enemy has available in the area of operations/area of influence (AO/AI) during a selected time period.
- How the enemy would employ chemical, biological, flame, or smoke to support his battle plan.
- Areas of likely employment based on threat employment doctrine.
- Detailed analysis of terrain and weather in the unit's AO during each period of interest and how they could impact on CB, flame, and smoke warfare.
- MOPP guidance for each period of interest (such as, minimum MOPP, automatic masking).
- Alternative actions the commander can initiate prior to the phase time line in question so as to minimize degradation of forces.
- Continuous monitoring of intelligence messages and radio traffic for any CB related information which could be important to the unit's mission.

It is important that the chemical officer/NCO be succinct during the commander's briefing or have his information presented by the S3 during his portion of the briefing. Therefore, for input to be addressed, chemical personnel must be a player in the IPB process. Although it is developed under the direction of the S2, once completed, the decision support template (DST) becomes an operational document and is briefed to the commander by the S3. As active participants in the IPB process, the CB concerns will be included in the threat analysis and shown usually on the IPB template. It is through this participation that the chemical staff best serves the commander as special staff warfare experts, for the appropriate templates of IPB process will include CB concerns and visually present them, in a

user-friendly manner, to the commander.

During battle management activities, the chemical staff advisor works with the S2 on the IPB. He coordinates with the intelligence officer to analyze and identify chemical targets based on threat, terrain, and the AO. Potential threat chemical targets could be key terrain, choke points, command and control facilities, counterattack routes, mobility corridors, troop concentrations and rear area assembly points.

A CB vulnerability assessment constitutes an important part of battlefield assessment and risk analysis and is a primary means through which the chemical staff advisor participates in the battlefield assessment process.

In this assessment, the chemical officer must develop information for integration into the various staff estimates. From the S2, the chemical officer/NCO obtains—

- Time period of interest.
- Threat probable courses of action and intent.
- Names areas of interest (NAIs) and target areas of interest (TAIs).

Summary of enemy activity, including any CB attacks, movements of CB equipment or material, or presence and level of training of threat forces, and indicators of enemy CB warfare comments such as queuing up weather radar.

Specific items of interest from the S2 would be:

- Direction and speed of prevailing winds.
- Average temperature and humidity and how these weather conditions may effect CB warfare agents, terrain, availability of water sources, transportation assets (railways, airfields, road networks) available for shipment of CB munitions, and the availability and location of industrial assets capable of producing and/or weaponizing CB warfare agents, availability of CB agents and delivery systems, and location of stockpiles.

From the Fire Support Officer (FSO), the chemical officer obtains information on casualty percentages from friendly and threat conventional munitions. Examples of information obtained might include—

- Casualty percentages based on target size
- Casualty percentages based on weapon systems

The chemical staff should also prepare a list of information that is compiled from various sources (news bulletins, spot reports, intelligence summaries (INSUMs), and is general in nature. This information, when viewed as a single event, may appear to be meaningless. However, when added to other pieces of information it may provide the key that connects the information and present the best view of the enemy's intent. Items of general information include, but is not limited to the following—

- Availability of CB defense equipment to enemy

forces. If no protective equipment is available (such as MOPP, antidotes, masks) it may indicate that the enemy does not intend on using CB weapons.

- Amount of overhead cover or collective protection shelters or systems; if enemy forces seek overhead cover or move into collective protection shelters, it may indicate that the enemy intends on using CB weapons.

- Stated national policy or philosophy on the use of CB weapons. Has the enemy declared a no use, first use or limited use only for retaliation in kind policy? Does the enemy consider the use of flame or smoke as CB agents?

- Leadership—Is the enemy's national or military leadership willing to use CB weapons on their own territory or expose their own populations to the hazards generated from CB munitions?

- If the enemy does not possess CB munitions, the capability to produce agents or expertise to employ munitions; have attempts been made to gain this ability? Reports indicating the presence of advisors from other nations working with enemy forces, international trade agreements or shipments of agricultural equipment (such as sprayers, fertilizers, insecticides or raw chemicals) may provide insight to the enemy's intent.

Once information is gathered, it will provide input to the formulation of the CB Threat Status.

## CB Threat Status

US forces may not have to carry CB defense equipment (such as MOPP) based on the initial threat estimate. If the threat condition were to change and indicators were present to suggest the possible use of CB agents by the threat forces, CB defense equipment would be deployed forward (such as division support area or to the brigade support area). These stocks may be prepalletized for immediate deployment by aircraft to the affected unit if required. However, this decision must be made based on available aircraft or other transportation systems. This could be done so that the forces would not have to carry the mission oriented protective posture (MOPP) ensemble in their field pack, ALICE (ruck sacks).

The minimum CB threat status is set at division or separate brigade level and is a flexible system determined by the most current enemy situation, as depicted by the continuously updated IPB process. This allows local commanders to increase the threat status as conditions change in their area of operations. Threat status governs the initial deployment of chemical assets (such as equipment or units) and the positioning of those assets on the battlefield or in the operational area. The CB threat status serial numbers are for planning purposes in accordance with STANAG 2984. These numbers, however, may be substituted for a color code (serial 0 =

white; serial 1 = green.). It does, however, require chemical personnel at brigade and division level to stay abreast of the intelligence picture. The CB threat status is outlined below—

### a. Serial 0 (none).

1. The opposing force does not possess any CB defense equipment, is not trained in CB defense or employment and do not possess the capability to employ CB warfare agents or systems. Further, the opposing force is not expected to gain access to such weapons and if they were able to gain these weapons, it is considered highly unlikely that the weapons would be employed against US forces.

2. Under this status a deploying force would not have to carry CB defense equipment nor decon assets. However, protective masks should be carried. Chemical personnel should concentrate efforts in smoke, herbicides, flame field expedients (FFE) and monitoring threat communication channels for CB threat indicators.

### b. Serial 1 (low).

1. The opposing force has an offensive CB capability, has received training in defense and employment techniques, but there is no indication of the use of CB weapons in the immediate future. This indication may be based on whether CB munitions are dispersed or deployed, or the stated objectives and intent of opposing forces.

2. Given this threat status, all personnel carry their individual defense equipment or chemical defense equipment stockpiles are identified and would be readily available for deployment to the operational area if the threat status should increase. NBC reconnaissance systems deploy to the operational area of interest to provide a monitoring capability. Chemical personnel continue to concentrate their efforts on NBC planning and analysis for threat indicators.

### c. Serial 2 (medium).

1. The opposing force is equipped and trained in CB defense and employment techniques. CB weapons and employment systems are readily available. CB weapons have been employed in other areas of the theater. Continued employment of CB weapons is considered probable in the immediate future. Indicators would be—

- CB munitions deployed to either field storage sites or firing units.
- Enemy troops wearing or carrying protective equipment.
- CB recon elements observed with conventional recon units.
- CB decon elements moved forward.

2. Unit CB defense equipment should be either pre-palletized and located forward for easy access or

issued to the soldiers responsible for use within the unit. Individual soldiers should wear MOPP levels 1 or 2; MOPP 0, if MOPP gear is readily available. Erect collective protection shelters if the tactical situation permits. Personnel and equipment should be kept under cover as much as possible to protect them from contamination. Chemical Downwind Messages (CDMs) should be sent to subordinate units. Decontamination assets, CB recon assets and smoke support should be deployed as part of the force structure. Detection and monitoring (such as CAM) equipment should be issued to the operators. Unit should fill M11 and M13 Decontamination Apparatuses (DAP) and mount on vehicles.

**d. Serial 3 (high).**

1. The opposing force possesses CB warfare agents and delivery systems. CB defense equipment is available and training status is considered at par or better than that of the United States. CB weapons have already been employed in the theater and attack is considered imminent. Indicators are—

- CB attack in progress but not in your area of operation.
- CB warnings/signals to enemy troops.
- CB munitions delivered to firing units within range of friendly forces.
- Movement of surface-to-surface missiles to a launch site.

2. US forces should deploy with CB defense equipment in the unit load. Soldiers should either carry the overgarments in their rack sacks, CB bag, or wear the overgarments. This will depend on the CB threat to the airfield or port on which they land. Soldiers should change protective mask filters prior to deployment. Decontamination and CB recon assets should be task organized and moved forward. Contingency stocks of CB defense equipment may be moved forward to the battalion trains. CDMs are initiated and place collective protection systems into a state of readiness including those systems in combat vehicles.

This threat status can be used as a single number representing both C and B or as individual C and B statuses. It is possible to have a C status of three and a B status of zero. This threat status provides the commander with guidance for deployment and operational purposes. It allows the commander to tailor chemical units to fit any situation.

Threat status can change rapidly. Although a C status of zero may exist during deployment, the opposing force may seize industrial chemicals or obtain warfare agents from a sponsoring nation. Therefore, the ground commander must be capable of upgrading the CB defense posture quickly.

To assist in the formulation of the threat status, the chemical staff, (in conjunction with the S2) must analyze all information received. A tool in this analysis is the threat status matrix depicted in figure 1-1.

CONDITION	SERIAL NUMBER			
	0	1	2	3
<b>A. Enemy force information—</b> • training status • NBC equipment availability • wearing overgarments • in collective protection shelters, in positions with overhead cover, or exposed				
<b>B. CB weapon systems—</b> • availability of CB weapons • CB weapons moved to firing unit • or launch sites				
<b>C. Enemy CB Policy and Capabilities—</b> • what is enemy's stated policy on CB weapons employment? • can enemy produce CB agents? • has industrial output increased or changed for production of CB munitions or protective equipment?				

Figure 1-1. CB Threat Status Matrix.

Use X's to mark applicable boxes or degree of threat. Total columns and use serial number with largest number of X's as the current threat status.

More than one matrix may be necessary to determine the threat status for chemical and biological attack.

To use the matrix, place an "x" in the appropriate block. Add each column; and whichever column has the most "x's" provides a means to identify what threat status serial number could be used to identify an indication of the enemy force intent. If an overall threat status cannot be determined due to an informational shortfall, collection assets should be reallocated or positioned to gain the needed information.

Once the threat status estimate has been assessed the chemical staff must analyze the protection level required for friendly forces. This is accomplished by using MOPP analysis—key factors include analyzing mission, environment, and soldier factors—as discussed in FM 3-4 and the factors listed below.

- Understanding the mission and commander's intent for friendly forces.
- Capabilities and level of training of friendly forces.
- MOPP analysis and work degradation factors contained in FM 3-4.
- Availability of chemical defense equipment and decontamination assets. In this regard, information may be obtained from the S2 or G5.

Other factors include—

- Location and availability of desalination plants (for arid areas).
- Location of civilian chemical manufacturing and storage facilities. Chemicals at these facilities may be used, through civilian contract, for supplementary decon supplies. Further, chemicals or hazardous materials stored in these facilities may produce areas of contamination if storage containers leak (either intentional or unintentional). To assess these hazards and how such a leak may impact on operations refer to Department of Transportation (DOT) Regulation 5300.3, Emergency Response Guidebook or the Department of Defense (DOD) Regulation 4145.19-R-1, Hazardous Materials Storage and Handling criteria.
- Availability of civilian contracted labor and water transport for decon operations.
- For urban areas, location of car washes. These car washes may be used in lieu of hasty decon stations. Obtain data on local fire hydrants (such as location, hookups). Hydrants may be used to provide water for decon operations.

The chemical staff must properly prepare the threat status and identify the protection level required for friendly forces to withstand an CB attack. This information is vital to the commander and for the successful accomplishment of the mission. The commander may be required to reallocate or position units on the battlefield to reduce vulnerability to an attack.

## Chemical Vulnerability Analysis

There is no difference in vulnerability analysis procedures between chemical agents and biological toxins. The following applies to both.

Unit vulnerability to a CB attack depends primarily on the protection the unit has taken and the type and amount of chemical agents delivered. For nonpersistent agents, the risk of casualties to units in MOPP 4 is negligible. This is also true for persistent agents if appropriate and timely decon measures are taken. Persistency, as defined in FM 3-9, is an expression of the duration of effectiveness of a chemical agent. This is dependent on physical and chemical properties of the agent, weather, methods of dissemination, and conditions of terrain. Nonpersistent agents generally include: choking agents, blood agents, and G-series nerve agents. Persistent agents generally include: blister agents, VX, GD and thickened nerve agents. If personnel are forced to stay in MOPP gear, performance is degraded and heat casualties may occur. Refer to FM 3-4 for detailed information on

degradation factors. The commander must achieve a balance between reducing the number of casualties from the attack, avoiding heat casualties, and reducing individual performance degradation.

Analyzing chemical vulnerability is difficult. Casualties can result from on-target attacks, off-target attacks, downwind hazards, and residual liquid contamination. Table 1-1 is a guide to help evaluate chemical hazard vulnerability. The chart is safesided and assumes a direct attack on troops in MOPP 1 or 2. Use the chart in the same manner as the radius of vulnerability tables for nuclear weapons. Remember that chemical weapons are delivered as battery or battalion volleys and not single munitions as with nuclear weapons.

If troops are wearing MOPP 4 at the time of the attack, reduce these percentages to a negligible level.

The figures in Table 1-1 are for employment under optimum attack conditions. Optimum conditions for employment of chemical weapons is generally considered to be stable or neutral temperature gradients and light winds less than 10 kmph. If troops are in some form of shelter such as a building, the percentages initially will be less. The percentages will also be less if high winds exist or during hot temperatures.

Table 1-2 shows the effects of temperature change on an agent's persistency. Cooler conditions increase the persistency of chemical agents. As a general rule, persistency triples as contamination levels increase from moderate to heavy. Moderate contamination is defined as one gram of agent per square meter. This concentration can be further defined as the amount of vapor contamination that would cause one-to-four bar display on the Chemical Agent Monitor (CAM). Heavy contamination is defined as ten grams or more of agent per square meter. Heavy concentrations would cause five-to-eight bars on the CAM. Moderate and heavy

*TABLE 1-1. Casualty estimate for initial chemical hazards.*

TYPE MUNITION	TARGET RADII (METERS)	PERCENT CASUALTIES*			
		NONPERSISTENT		PERSISTENT	
		NERVE	BLOOD	NERVE	BLISTER
BURSTING	150	40	10	25	10
	500	30	5	20	5
	1,000	15	2	15	2
SPRAY	150			45	10
	500			30	5
	1,000			20	2

\*Troops in MOPP 1 or 2.  
 \*For troops in MOPP 4, reduce casualty percentages to a negligible level.

*TABLE 1-2. Chemical Agent Persistency in Hours on CARC Painted Surfaces.*

Temperature		GA/ GF <sup>1</sup>	GB <sup>2,3</sup>	GD <sup>2,3</sup>	HD <sup>1</sup>	VX <sup>2,3</sup>
C°	F°					
-30	-22	*	110.34	436.69	**	***
-20	-4	*	45.26	145.63	**	***
-10	14	*	20.09	54.11	**	***
0	32	*	9.44	22.07	**	***
10	50	1.42	4.70	9.78	12	1776
20	68	0.71	2.45	4.64	6.33	634
30	86	0.33	1.35	2.36	2.8	241
40	104	0.25	0.76	1.25	2	102
50	122	0.25	0.44	0.70	1	44
55	131	0.25	0.34	0.51	1	25

**NOTE**  
 1 For grassy terrain multiply the number in the chart by 0.4.  
 2 For grassy terrain multiply the number in the chart by 1.75.  
 3 For sandy terrain multiply the number in the chart by 4.5.  
 \* Agent persistency time is less than 1 hour.  
 \*\* Agent is in a frozen state and will not evaporate or decay.  
 \*\*\* Agent persistency time exceeds 2,000 hours.

contamination detected on M9 Chemical Agent Detection Paper is depicted in Figures 1-2 and 1-3.

Chemical agent persistency data given for surface winds of 10 kmph. For other surfaces use the following multiplication factors for the times given alkyd paint = 1.3, bare soil = 4.0. Agent HL is not shown. To approximate HL use GD persistency times. To convert C° to F°; F° = 1.8C + 32. To convert F° to C°; C = (F - 32) ÷ 1.8. All concentrations of contamination is considered to be heavy (10 grams square meter). One week is considered to be 168 hours. One month (30 days) is equal to 720 hours. One year (365 days) is equal to 8640 hours.

The information presented in tables 1-1 and 1-2 provide a quick planning guide for chemical agent persistency. For a more detailed discussion of chemical agent persistency, see FM 3-4, Chapter 3.

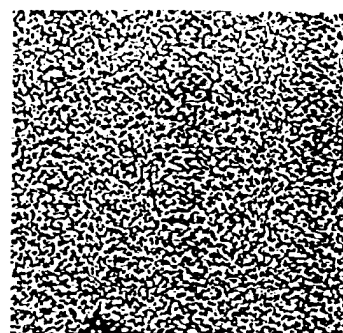

**ARTILLERY**

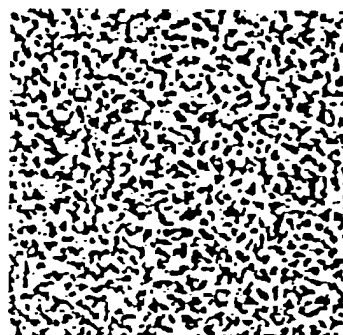

**AIRCRAFT SPRAY**

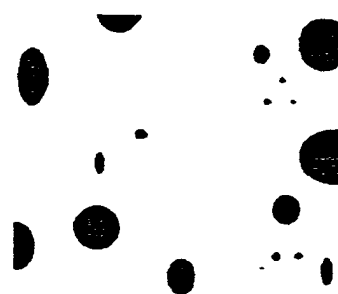

**MISSILE**

*Figure 1-3. Heavy liquid contamination on M9 paper (10 grams/square meter).*

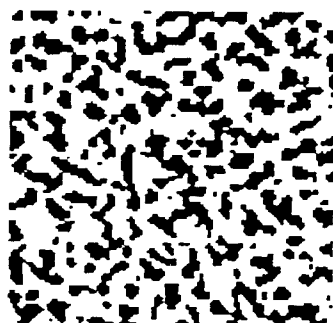

**ARTILLERY**



**AIRCRAFT SPRAY**



**MISSILE**

*Figure 1-2. Moderate liquid contamination on M9 paper (1 gram/square meter).*

## Biological Vulnerability

### Analysis

The effects of biological agents are very unpredictable, unlike nuclear and chemical weapons. Biological agents are effective in low concentrations, and personnel outside the target area may be affected. Vulnerability reduction methods include

- Employ a good immunization program before deployment
    - Ensure personnel wear MOPP gear.
    - Eat food only from protective wrappers and sealed containers.
    - Drink only purified water.
    - Report and seek treatment for illness promptly.
    - Ensure personnel practise good personnel hygiene.
- For a more detailed discussion on biological warfare agents, their properties and effects, refer to Chapter 4.

### Vulnerability Reduction

Active measures prevent the enemy from using CB weapons; passive measures increase survivability. Individual and unit collective measures are only discussed briefly here. See FM 3-4 for detailed information.

### Active Measures

Active measures are those measures taken to find and destroy either the munitions or the delivery systems. Destruction of delivery systems and munitions is the best method of reducing the chances of being attacked.

The destruction of stockpiles of CB munitions and production facilities is usually beyond the capabilities of lower level commanders. Echelons above corps have the responsibility and sufficient assets for finding and destroying these targets.

Corps and divisions do not have the capability to locate and destroy stockpiles or production facilities; but they do have the capability to find and destroy delivery systems. Recon flights, counterbattery radar, and other intelligence collection assets are used to find delivery systems such as long-range cannons and missile systems.

### Passive Measures

It is not possible to destroy all threat CB munitions and/or delivery systems; units must always take precautions to avoid being targeted or to reduce the effects of an attack if one does occur. These are passive measures. All units must use passive measures as part of normal operations to reduce the effects of operating under CB conditions. These measures include—

- Plan ahead.

- Avoid detection.
- Provide warning.
- Maintain discipline.
- Seek protection.
- Disperse.
- Remain mobile.
- Cover supplies and equipment.
- Prevent spread of contamination.
- Follow unit SOPs.
- Camouflage.

### Plan Ahead

Tasks may become more complicated in a CB environment due to the degradation of protective equipment. Again, FM 3-4 contains tables to help commanders estimate how long it takes to accomplish missions in an CB environment. Commanders must take time to carefully think out Courses Of Action (COA's) and allow for the additional time requirement. This is commonly referred to as wargaming. A bad decision could cause the unit to become needlessly contaminated or suffer casualties. Use the CB threat status for planning and stocking CB defense/equipment. Units must prepare to continue the mission after an CB attack. Following an enemy CB strike, commanders must quickly assess the damage and reconstitute lost or weakened units.

### Avoid Detection

Avoiding detection is the best way to prevent CB attacks. Do this by employing good operational security (OPSEC) measures. These include camouflage, light discipline, and especially, signal security. Both active and passive measures must be used to prevent the enemy from gaining target information. Use defensive electronic warfare (ECM and ECCM) to reduce the chances for identification and location. Once a CB attack is detected or suspected, commanders should consult higher headquarters for guidance if unit displacement is necessary.

### Provide Warning

If the unit is unable to avoid CB attacks, early warning of battlefield hazards is very important. The NBC Warning and Reporting System (NBCWRS) notifies units that adjacent units have been attacked or that a downwind hazard is present. Automatic alarms, such as the M8A1, positioned upwind to detect the arrival of an agent cloud may warn of probable attacks. When no NBCWRS warning is received, these alarms let the unit adjust MOPP levels to meet the threat. Troops must be able to identify CB attacks and take appropriate actions. CB recon teams using the NBC Reconnaissance System (NBCRS) alert moving units before they enter contaminated areas.



### **Maintain Discipline**

The unit must maintain discipline and confidence in their ability to survive and operate if they are to overcome the shock of an CB attack and continue the mission. Troops must be conditioned physically and mentally to wear and function in MOPP gear for extended periods of time. Commanders must be able to rely on their troops to wear MOPP gear when required and to remain in MOPP until told to reduce the level. Again, plan ahead. Develop MOPP acclimation plans within the unit. Use these plans whenever possible during unit training. Use the information contained in FM 3-4 to assist in developing a unit acclimation plan.

### **Seek Protection**

Natural terrain may provide shelter from the effects of CB weapons. However, ditches, ravines, and natural depressions allow accumulation of chemical agents. Heavy forests and jungles protect against liquid chemical agents, but vapor hazards will increase.

Foxholes with overhead cover and shelters offer good protection against the explosive and liquid effects of CB weapons. However, any overhead cover such as tents, tarpaulins, and ponchos offer at least some protection from liquid chemical agents. Use NBC protective covers (NBC-PC) whenever possible.

### **Disperse**

Combat service support (CSS) installations and troops in compact assembly areas are vulnerable to CB weapons. Commanders must determine how much dispersion is needed. Dispersion must reduce vulnerability but not hinder operations or prevent the unit from concentrating when necessary. Supplies especially food, POL, and ammunition must be dispersed so they will not all be destroyed at once. The more dispersed a unit is, the longer it will take to do even routine tasks. The degree of acceptable dispersion depends upon mission, enemy, terrain, troops, and time available (METT-T).

### **Remain Mobile**

Tactical mobility gives the commander the best chance for avoidance. Constant movement prevents the enemy from pinpointing locations and accurately employing CB weapons. However, the battlefield will be a difficult place in which to maneuver. Contaminated areas, tree blowdown, urban rubble, fires, flooding, fallout, and craters are obstacles that will have to be dealt with. CB recon teams and the serving S2/G2 can provide useful information. The best source of information on mobility routes, however, is the Movement Control Center (MCC).

### **Cover Supplies and Equipment**

Store supplies and equipment under cover to prevent contamination. Buildings offer excellent protection. NBC protective covers (NBC-PC), tarpaulins, pallets, packing materials, dunnage, and plastic (sheets, bags, and rolls) all can be used. Field expedient covers, especially canvas and cardboard, provide protection from liquid agents for a short period of time. Contamination seeps through all such covers, however, the NBC-PC will provide protection for up to 24 hours. Units must replace the covers as soon as possible after heavy contamination. Canvas will keep out more than 95 percent of liquid contamination if it is removed within 60 minutes after the attack. Although these covers may provide protection against liquid agents, a contact hazard will remain until the agent on the ground and the protective cover has weathered.

### **Limit Exposure**

All plans should include postattack procedures for limiting exposure to CB hazards. The longer a person is exposed to chemical contamination, the greater the chance of becoming a casualty. Only personnel required to accomplish a mission are sent into a contaminated area.

Limit exposure with time. By waiting to enter a contaminated area, the contamination level will usually be reduced and with it the chance of exposure. Exposure can also be accidental. Personnel may not know that equipment is contaminated. Usually, this can be prevented by always marking contaminated equipment. But there are places where CB contamination hazards can accumulate such as in air filters. All engines have air filters which trap CB contaminants. These contaminants accumulate. So even if the hazard area is small, it can be deadly. Persons working around equipment should be aware of hidden hazards. Always dispose of contaminated collectors, such as air filters, as contaminated waste.

### **Prevent Spread of Contamination**

Limit the number of personnel and amount of equipment in the contaminated area. Confine CB contamination to a small area as possible. This begins with monitoring to determine the amount and extent of contamination. Units moving from a contaminated area into a clean area should decontaminate at or near the edge of contamination. Mark all contaminated areas and report them to higher headquarters and adjacent units to prevent them from entering the contaminated area unknowingly.

If the situation permits, contaminated material can be left and allowed to weather. If the equipment is mission essential, it must be decontaminated or brought back to

the rear for decontamination.

Decontaminate as far forward as possible. If contaminated material must be moved, the unit runs the risk of transferring contamination to road networks or ground surface which is proportional to the amount of contamination on the material, location of the contamination, type of contamination, and type of surface on which the contamination is present. When moving this equipment:

- Notify the MCC of contaminated vehicles or contaminated routes.
- Use as few transport vehicles as possible.
- Use one route (especially around congested areas).
- Monitor the route periodically for contamination.
- Cover the material to keep contamination from being blown onto the road. (Weigh the risk of ground contamination with additional burden of decontamination/disposing of potentially contaminated covering material).
- Warn personnel downwind if a vapor hazard is

present.

- Monitor and decontaminate transport vehicles before transporting noncontaminated material.
- Ensure transport crews wear appropriate MOPP gear.

When contaminated material or waste material must be destroyed, either burn or bury the contaminated material. Agents destroyed by burning produce a vapor hazard. So if material is burned, send a warning to downwind units. Burial is effective for all types of contamination. Mark and avoid the area where contaminated waste is buried. Procedures for marking contaminated waste burial sites is outlined in FM 3-5. This consists of submitting an NBC-5 Chemical Report outlining the contaminated waste burial site. However, this report must be sent by the NBCC so that line item Alpha, (strike serial number) may be assigned. The unit, therefore, that closes the decontamination site, must notify the NBCC.

## Chapter 2

# NBC Warning and Reporting System (NBCWRS)

The primary means of warning units of an actual or predicted CB hazard is the NBC Warning and Reporting system (NBCWRS). It is a key in limiting the effects of CB attacks. The NBCWRS allows units to determine required protective measures and plan operations. Units take action depending on the mission and type of hazard present. If the mission allows, affected units alter plans to avoid the hazard. Otherwise, the units upgrade protective measures and occupy or cross the hazard area

### Standard NBC Reports

The NBCWRS consists of six reports. Each is standardized by ATP 45/STANAG 2103 Change 4, dated Jan 89 and the United States Message Text Format (USMTF). The U.S., NATO and British, Canadian, and Australian use the same message formats. The six standard reports are—

- NBC 1-Initial report, used for passing basic data compiled at unit level.
- NBC 2-Report used for passing evaluated data.
- NBC 3-Report used for immediate warning of predicted contamination and hazard areas.
- NBC 4-Report used for passing monitoring and survey results.
- NBC 5-Report used for passing information on areas of actual contamination.
- NBC 6-Report used for passing detailed information on chemical or biological attacks.

The reports use standard formats to shorten the message being passed. The warning and reporting system is based on a code letter system. The meaning of each letter used to transmit an NBC message is described in Table 2-1 and GTA 3-6-5. The following paragraphs described each report. Specific instructions for acquiring the information and sending the report are discussed later in this chapter. Refer to Chapter 4 for specific use of the NBCWRS for biological attacks.

### NBC 1 Report

The NBC 1 Report is the most widely used report. The observing unit uses this report to provide CB attack data. All units must be familiar with the NBC 1 Report format and its information. The unit must prepare this report quickly and accurately and send it to the next higher headquarters.

Battalion and higher elements decide which NBC 1

*TABLE 2-1. Meaning of line items in NBC reports.*

Line	Chemical and Biological	Remarks
A	Strike serial number.	Assigned by NBC center.
B	Position of observer..	Use coordinates (UTM or place)
C	Direction of attack from observer.	Direction measured clockwise from grid north or magnetic north (state which) in degrees or mils (state which)
D	Date-time group for start of attack.	Designate time zone used.
E	Date-time group for end of attack.	Designate time zone used.
F	Location of area attacked.	Use grid coordinates (or place). State whether the location is actual or estimated.
G	Kind of attack.	State whether attack was by artillery, mortars, rockets, missiles, bombs, or spray.
H	Type of agent/type of burst/persistency. P (persistent) or NP (nonpersistent).	Specify air, or surface. State whether ground, airburst, or spray attack for chemical.
I	Number of munitions or aircraft.	If known.
J	NA	
K	Description of terrain and vegetation.	NBC 6 only.
L	NA	
M	Line MIKE removed from CB reports by ATP 45/STANAG 2103.	
N	NA	
O	NA	
P	Line PAPA removed from system by ATP 45/STANAG 2103	
PA	Predicted hazard area (coordinates).	If wind speed is 10 kmph or less, this item is 010 (the radius of the hazard area in km).
PB	Duration of hazard in attack and hazard areas.	In days, hours, minutes, etc..
Q	Location of sampling and type of sample.	UTM or place. State whether the test was air or liquid.

*Table 2-1. Meaning of line items in NBC reports (continued).*

Line	Chemical and Biological	Remarks
Q	Location of sampling and type of sample.	UTM or place. State whether the test was air or liquid.
R	NA	
S	Date-time contamination detected.	State time initial identification test sample was taken. State time zone used.
T	Date-time of latest contamination survey of the area.	NBC 5 and NBC 6 reports only.
U	NA	
V	NA	
W	NA	
X	Area of actual contamination.	Plot in yellow.
Y	Downwind direction of hazard and wind speed.	Direction: 4 digits (degrees or mils); Wind speed—3 digits (kmph or knots).
Z	NA	
ZA	Significant weather phenomena.	Air stability (1 digit). Temperature in centigrade (2 digits). Humidity (1 digit). Significant weather phenomena (1 digit). Cloud cover (1 digit). See Figure 3-11, Chapter 3, for explanation of codes.
ZB	Remarks.	Some NATO forces will use GENTTEXT.
ZI	Line ZULU INDIA removed from system by ATP 45/STANAG 2103.	

Reports to forward to the next higher headquarters. If several reports are received on the same biological or chemical attack, then a consolidated NBC 1 Report is forwarded. This reduces the number of reports to a manageable level. If the NBC 1 Report, however, is based on a chemical agent alarm going off and there is no other indication of an attack (such as in-coming artillery rounds) the battalion chemical staff should inform higher headquarters, but request that the sending unit verifies the attack with two or more sampler/detector tickets from a M256 Chemical Agent Detector Kit. The attack should be verified at this level before the NBC 1 Report is sent to higher headquarters. This helps to eliminate a false report from causing an entire brigade task force or division to go into Mission Oriented Protective Posture (MOPP). NBC 1 Reports are not routinely passed to corps or higher NBC centers (NBCC) except for the initial use report.

Precedence of the NBC 1 Report depends on whether or not it is an initial report. The initial use report is FLASH precedence, all others are IMMEDIATE precedence.

Individuals identified by unit SOP submit observations to the unit NBC defense team at company/battery or troop level. They need not use the NBC 1 Report format or individual line items of the NBCWRS to pass this data to the NBC Defense Team. (This report is generally in the form of a SPOT report or SALUTE report). The unit NBC defense team normally consists of the unit chemical NCO (54B20) or an NBC NCO that has been school trained at an area NBC defense two week school, an officer and an enlisted soldier (Specialist 4 or above) that has attended the same two week school. These soldiers will have the expertise at unit level of advising the commander on NBC defense matters and forming NBC reports.

Normally, the unit NBC defense team formats NBC 1 Reports. This ensures the content of the report is known to the commander or his or her representative. It also ensures that the report is in the proper format and is as correct as possible.

All data is sent in a single, complete NBC 1 Report. Do not divide data into two parts to create a subsequent report. NBC 1 Reports are not attack notifications, they simply pass data. Separate procedures must be developed for attack notification and are beyond the scope of this manual. Attack notification may take the form of a SALUTE, SPOT or SITREP Report and should be addressed in detail in unit SOPs.

### Initial Use Report

The first time a CB weapon is used against US forces the observing unit will send the NBC 1 Report with a FLASH precedence. Each intermediate headquarters will forward the report with a FLASH precedence (or IMMEDIATE precedence if a previous NBC 1 Report has been forwarded). If the report is of a second attack within the division, use IMMEDIATE.

The observer determines the date-time group of the attack, location of the attack, means of delivery, type of burst (air or ground), and if possible, type of agent. The NBC defense team then formats the NBC 1 Report and forwards it to the next higher headquarters. All units prepare and forward NBC 1 Report.

Battalion and higher headquarters screen NBC 1 Reports and decide which report(s) to forward. If the headquarters receives several reports pertaining to the same attack, it forwards a consolidated NBC 1 Report instead of separate reports. All reports must include line items Bravo (position of observer), Delta (date/time group), Hotel (type of burst), and either Charlie (direction of attack) or Foxtrot (location of attack). Use

other line items if the information is known. If the unit is capable of providing local weather information as listed in line items Yankee (downwind direction of hazard and wind speed) and Zulu Alpha (significant weather phenomena) this information should be included in the report.

### **NBC 2 Report**

The NBC 2 Report is based on one or more NBC 1 Reports. It is used to pass evaluated data to higher, subordinate, and adjacent units. Division NBCC is usually the lowest level that prepares NBC 2 Reports. Brigade and battalion NBC personnel may prepare the NBC 2 Report if they have sufficient data. However, these units will not assign a strike serial number.

Units use the NBC 2 as a factor in determining whether to adjust MOPP levels, and to assist in planning future operations. Line items Alfa (strike serial number), Delta (date/time group), Foxtrot (location), Golf (means of delivery), and Hotel (type of burst) are always contained in the NBC 2 Chemical or Biological Report. Items Yankee (downwind direction speed), Zulu Alfa (weather), and Zulu Bravo (remarks) should be included in the chemical or biological report. Line item Zulu Bravo (remarks) should include the type and case of attack, if known. Use other line items if the information is known.

### **NBC 3 Report**

Division NBCC uses the NBC 2 Reports and the current wind information to predict the downwind hazard area. This is sent as an NBC 3 Report. It is sent to all units that could be affected by the hazard. Each unit plots the NBC 3 Report and determines which of its subordinate units are affected and warns those units accordingly.

The NBC 3 Report is a prediction of a downwind hazard area. This prediction is safesided to ensure that a militarily significant hazard will not exist outside of the predicted hazard area. Commanders should use the report as battlefield intelligence when considering courses of action. When a unit is in a downwind hazard area, the commander must decide whether to stay or move. This decision is based on the mission, and higher headquarters guidance. As the Automated Nuclear, Biological, and Chemical Information System (ANBACIS) is improved, the commander will be able to view the modeled hazard area on a computer screen instead of basing his decision on the safe-sided STANAG plots. This will provide a more realistic depiction of the hazard area. ANBACIS is addressed in more detail later in this chapter.

Units within the chemical downwind hazard area must adjust their MOPP level, if necessary. They must ensure

that chemical agent alarms are placed far enough upwind to provide adequate warning. The NBC 3 Chemical Report is re-evaluated every two hours. The hazard prediction could change significantly. Units currently affected and those previously affected must be notified that they are in (or are no longer in) the hazard area. Line items Alfa (strike serial number), Delta (date/time group), Foxtrot (location), Hotel (type), Papa Alfa (predicted hazard area), Papa Bravo (duration of hazard) (if ground contamination is present), Yankee (downwind hazard and speed), and Zulu Alfa (weather) are used for a chemical hazard prediction. In order that a recipient of an NBC 3 Chemical Report be able to plot the downwind hazard area easily and quickly, Line Zulu Bravo may contain the following information—type and case of attack, or the downwind hazard distance (DHD). Use other line items if the information is known.

### **NBC 4 Report**

Actual contamination is reported using an NBC 4 Report. Separate NBC 4 Reports are plotted on the tactical map to show where the hazard exists. If monitoring information is incomplete, a survey may be directed. Line items Hotel (type of attack), Quebec (location of sample), and Sierra (date/time of contamination was detected) are reported for a chemical hazard. These items are used as often as necessary to complete the report. Other items may be included if available and necessary to complete the report. A contamination overlay is sent to all units by computer data base update, electrical facsimile, messenger, liaison officer, and the NBC 5 Report.

### **NBC 5 Report**

The NBC 5 Report is prepared from the contamination plot. This report is last in order because it consists of a series of grid coordinates. Often this message must be sent on FM radio nets. This requires lengthy transmission. The recipient is required to plot each coordinate and redraw the plot. Complete details can follow later on the facsimile or messenger-delivered plot.

For CB contamination, line items Alfa (strike serial number), Delta (date/time group), Hotel (type of burst), Sierra (date/time of sample), Tango (date/time of latest survey), and X-Ray (area of actual contamination) are reported.

With the exception of line item Alfa, when a user has previously received data through other NBC reports, the data need not be repeated on the NBC 5.

This message may be sent before or after a contamination plot has been received. The NBC 5 Report

is also used to report the closure of a decontamination site. The NBC 5 Report should include coordinates for the site and sump so as to notify other units of the contamination area.

## **NBC 6 Report**

This report summarizes information concerning a chemical or biological attack(s) and is prepared at battalion level, but only if requested by higher headquarters. It is used as an intelligence tool to help determine enemy future intentions. The NBC 6 Report is submitted to higher headquarters. It is written in narrative form, with as much detail as possible under each line item. The NBC 6 Report may also be used to warn and report suspected biological attacks. Information concerning this use of an NBC 6 Report is described in detail in Chapter 4.

## **Managing the NBC Warning and Reporting System**

Managing the NBCWRS is crucial for the success of a command. To be useful, CB information must be collected, reported, and evaluated. Once evaluated, it can be used as battlefield intelligence. Obtaining and converting CB information into usable CB intelligence does not just happen. The volume of information that needs to be collected and reported could easily disrupt both communications and tactical operations if not properly managed. This section describes what information is available and how that information gets to the person or unit needing it.

### **Collecting CB Information**

The first step in managing the NBCWRS is to determine what information is available and who is available to collect it. Two types of data must be collected. Observer data provides information that an CB attack has occurred. Monitoring, survey, and recon data provide information on where the hazard is located.

### **Observer Data**

Every unit is responsible for observing and recording CB attacks. But every unit does not automatically forward NBC 1 Reports. Any unit aware of a chemical or biological attack promptly prepares and forwards an NBC 1 Chemical or Biological Report.

### **Monitoring, Survey, and Reconnaissance Data**

NBC 1 Reports allow the NBCC to predict where the

hazards will be. This prediction (NBC 3 Report) is only an estimation of the hazard area. Feedback is needed from units to determine exactly where the contamination is located.

This feedback comes from monitoring, survey and recon (NBC 4 Reports). Monitoring and recon operations give the initial location of CB hazards to the NBCC. Initial monitoring and recon reports are generally forwarded through intelligence channels to the NBCC. This information may also be sent to the NBCC by ANBACIS. ANBACIS is the Automated NBC Information System and is described later in this chapter. The NBCC plots the information on the situation map. If more information is needed, the NBCC recommends a unit (picked because of its location and/or capability) to collect and forward the necessary data. This unit may be an organic unit NBC defense team or an NBC reconnaissance platoon from the divisional chemical defense company. Special operations forces will depend on special forces operational detachments (SFOD) with attached LB teams, special forces group (SFG) chemical detachments, or organic unit NBC defense teams. The reconnaissance platoon may be tasked organized to support a maneuver brigade in NBC reconnaissance collection efforts.

Collecting CB information is a joint effort between units and the NBCC. The unit does the actual collecting of information. The NBCC plans for and directs the collection effort. The division FSOP/OPORD/OPLAN should describe who collects and forwards CB information for evaluation. More detailed information concerning this collection effort is addressed in Chapter or in FM 3-19.

## **Evaluating CB Information**

The CB data must be collected and evaluated by the NBCC and used as battlefield intelligence. Units and intermediate headquarters use the raw data to develop CB intelligence for their own use until detailed results are available from the NBCC.

### **Unit Procedures**

Unit procedures for determining the location of contamination are simplified and less accurate than NBCC procedures. Emphasis is on speed rather than accuracy.

With-exception of designated observer reporting units, intermediate headquarters (such as battalion and brigade) consolidate and screen NBC reports to reduce the number sent to the NBCC.

### **NBCC Procedures**

Procedures used by the NBCC are more detailed and complex than those at unit level.

NBC 2, NBC 3, and NBC 5 Reports from division NBCC supersede those done by subordinate units.

## Transmitting CB Information

Procedures used to transmit CB information to and from the NBCC are an important part of the CB information system. Figure 2-1 shows the direction that various NBC reports travel. Usually the flow is through the chain of command—from company to battalion to brigade to division. There are exceptions to this—

- The NBCC may request data such as survey information. The unit doing the survey may report directly back to division. The monitoring unit must also send an information copy back to the parent unit for command and control (C<sup>2</sup>) and for reordering CB defensive stocks.

- Attached or OPCON units may have no direct contact with a parent unit. In these cases the headquarters to which they are OPCON passes CB information.

- Units that operate independently (such as military police or engineers) will report through the controlling headquarters.

The method of transmitting information depends on the tactical situation and mission of the unit. Methods are specified in FSOP/OPLAN/OPORD and unit SOP. At brigade and higher headquarters, NBC Reports usually

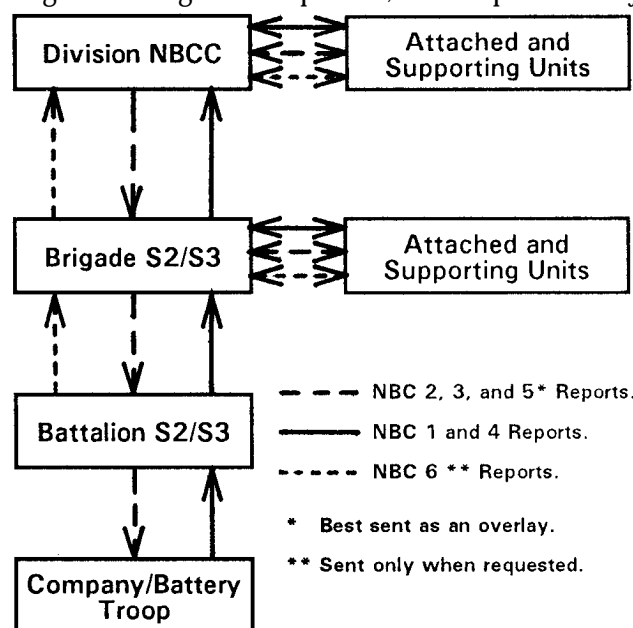

Figure 2-1. Flow of NBC Reports.

are passed on the intelligence net rather than the command net. At battalion level and lower there is generally only one FM net available. This net is required to communicate command information. Therefore, NBC Reports should be formatted ahead of time and be as short and concise as possible. In this case, wire communications are best. Support units use Admin-Log nets. However, these units need to also inform the brigade TOC or division TOC when operating in that units Area of Operations (AO). Wire communications are excellent, if available. There are numerous methods to communicate CB information. One of which is ANBACIS, which accesses information from the maneuver control system (MCS). The NBCC should evaluate all possible methods and select those that best suit the purpose. Again, this information should be contained in the unit SOP or current operations order.

Each unit and command element has a specific function in a CB environment. This function is in addition to normal combat functions. The exception to this is the NBCC whose primary function is NBC operations. The preceding pages described procedures and requirements for collecting, evaluating, and transmitting CB information. This section describes responsibilities at each command level and is intended to be only a guide.

### Actions at Unit Level

Unit level collection, processing, and analysis techniques are designed for rapid evaluation of CB data. The results are not as accurate as those obtained by the NBCC, but they are sufficient for planning until replaced by data from the NBCC. Although analysis techniques are similar for company, battalion, and brigade, each has specific responsibilities for collecting and processing CB information. The responsibilities are discussed here. Analysis techniques are explained in the appropriate chapter.

The major portion of CB information is collected and reported by company/ battery/ troop-level units. These units must be trained and equipped to—

- Report CB attack data using the NBC Warning and Reporting System.
- Monitor for chemical agents.
- Plot simplified downwind hazards.
- Identify toxic chemical agents.
- Collect and forward soil and water samples.
- Conduct chemical and biological surveys/reconnaissance.

Organization and training of personnel to perform these tasks will be in accordance with AR 350-42.

### Battalion Level

The battalion monitors the information gathering of

subordinate units. Battalion chemical personnel ensure each subordinate unit is trained. Battalion personnel also are trained to—

- Consolidate and forward NBC reports.
- Estimate effects of CB hazards.
- Disseminate information on CB activities.
- Coordinate unit CB recon elements with and through the battalion S2/S3 sections and the chemical company platoon leader tasked to support the battalion.
- Coordinate with Brigade to obtain additional smoke or decon assets, if required.
- Advise the commander on how to employ CB assets.
- Plan and supervise decentralized CB surveys.
- Maintain a CB situation overlay.

**Brigade/Task Force Level**

The chemical personnel at brigade must perform the same functions as battalion chemical personnel. Brigade personnel also must—

- Coordinate with all attached NBC units.
- Coordinate with other staff sections and advise them on CB matters.
- Plan and supervise decentralized CB surveys.
- Collect information from and assist CB personnel within the task force.

**NBCC Level**

NBCC techniques involve more complicated procedures and are based upon the comparison of data from many sources. Much of this data is not available to a single unit. In addition to performing detailed analysis, the NBCC also —

- Receives, collates, evaluates, and disseminates reports of enemy CB attacks.
- Prepares and disseminates wind messages.
- Estimates the effects of enemy and friendly chemical and enemy biological attacks, including hazard predictions.
- Coordinates recon and survey activities with higher, lower, and adjacent units.
- Maintains a CB situation map.
- Provides advise to G2 on CB intelligence matters.
- Provides technical assistance to all staff levels.
- Coordinates with other staff sections and advises those staff sections on CB matters.
- Provides technical assistance in the interrogation of POWs on CB matters. This technical assistance is generally in the form of providing the interrogator with a list of questions to ask the prisoner. The questions may include—
  - Employment tactics.
  - CB munitions.
  - Types of agents available.

- Defense training status.
- Types of defensive equipment used by soldiers.

**Chemical Attack Warning  
(CHEMWARN)**

The CHEMWARN message is very similar to the NBC 3 Chemical Report. The meaning and use of each line item are shown in Table 2-2. Figure 2-2, on page 2-7, shows some examples of CHEMWARN messages.

Two hazard areas exist for a chemical attack—the attack area and the downwind hazard area. Under normal conditions, a chemical attack will not be carried out if friendly troops are within the attack area. Personnel in the downwind hazard area may don MOPP gear.

*Table 2-2. Meaning and use of CHEMWARN line items.*

Line Item	Meaning	
A	Strike serial number or code word/nickname.	Indicate that this is a chemical attack.
D	Date-time group of attack.	Give only the date and time of the attack. This should be encoded.
F	Location of attack.	Grid coordinates of center of attack. If attack is spread over large areas, a series of coordinates may be given to indicate the center of mass of the attack. This should be encoded.
G	Delivery means.	Tell how delivered and how disseminated.
H	Type of agent.	Classify agent by physiological effect and duration of effectiveness.
PA	Attack area and predicted hazard area.	Six-digit coordinates will be given.
PB	Duration of hazard.	In days, hours, minutes, etc.
Y	Downwind direction and wind speed.	Downwind direction, four digits in degrees or mils (state which), wind speed, three digits in kmph only.

**Automated Nuclear,  
Biological, and Chemical  
Information System  
(ANBACIS)**

ANBACIS is a software information system which will support the chemical staff officer and NCOs as well as



Area of hazard	
<b>CHEMWARN</b>	
A	AF002Chem
D	020830Z
F	PG 560750
G	Artillery ground burst
H	Nonpersistent Nerve
PA	PG 556751 PG 559754 PG 632774 PG 610694 PG 558747
Y	0015 Deg 015 kmph

Multiple attack hazard area (sprayline)	
<b>CHEMWARN</b>	
A	AB104Chem
D	141330Z
F	UC310060 UC370061
G	Spray
H	Persistent Nerve
PA	UC 373071 UC 485013 UC 307900 UC 300060 UC 305068 UC 305068
PB	PB Attack area 2 to 4 days Hazard area 1 to 2 days

Figure 2-2. Examples of CHEMWARN messages.

chemical units (squad to brigade) with the communication, recordkeeping, and calculation of NBC warning and reports, tactical decision aids, and databases essential to accomplish their tasks. One module is the NBCWRS which is an automation of the manual data processing as described in this manual. ANBACIS was designed to operate on the Army common hardware and also to operate in the stand alone mode on any IBM compatible computer. ANBACIS is user friendly with drop down windows and is operated by chemical staff personnel.

It can receive any number of NBC 1 Reports and create the correct number of NBC 2 Reports. It will then convert the NBC 2 Reports to NBC 3 Reports utilizing the correct weather information that has been previously received electronically from the staff weather officer. It will take the basic wind report and create the Chemical Downwind Report in seconds.

ANBACIS supports battle management by—

- Reducing human error on assisting in soldier

endurance. By relieving the chemical staff from repetitious and intensive calculational tasks, the soldiers will be able to apply their skills more effectively at assisting the commanders and other staff members. By not expending time and effort on those tasks, they will be more mentally alert and less subject to making mistakes.

- Calculate the NBC 3 and 5 Reports from the NBC 1 and 4 Reports and then display them on the electronic map (E-MAP) with the units, boundaries, and other map information. This overlay information will be available to the other terminals for use in their planning and operations.

- Communication capability. ANBACIS will not have any inherent communications capability. It is designed to use the communications from the maneuver control system or army common hardware and software packages.

- Found at all force level staff sections (such as battalion, brigade, division), and chemical units down to squad level.

- Handle all NBC Reports 1 through 5. It utilizes many checks and constraints to prevent false information from being used. It will automatically look-up and utilize the correct weather information contained in the database. In addition, it will create flame field expedient plans, smoke plans, and NBC 4 Reports from monitor and survey reports.

- Operated by the normal Chemical Corps staff or unit representative, all enlisted and officers.

- ANBACIS is designed to work best in the maneuver control system organization. A stand-alone capability will be maintained to work on most IBM compatible computers. This will allow continuity of operations and allow work to be accomplished when separated from the MCS environment. When the operator returns to the MCS, he can load the plans into the MCS-ANBACIS using a diskette.

It has other modules including smoke plan creation and flame field expedients (FFE), and others.

For additional information on ANBACIS, refer to the ANBACIS User's Guide.

## Chapter 3

# Chemical Agents

Avoidance of chemical agents requires a complete understanding of physical characteristics, employment, and weather and terrain conditions. Units can then estimate when and where specific type of chemical agents will be used, where the hazards are, and how best to avoid them.

Threat forces are equipped, structured, and trained to conduct chemical operations. We expect them to use chemical agents as part of their conventional fighting capability because so much of their training revolves around the use of such agents.

The basic threat principle is to use chemical agents on unprotected troops to create casualties. Against protected troops, the primary purpose is to make the use of equipment, terrain, and operations more difficult. The use of chemical weapons by the threat forces initially may require a decision at the same level as nuclear weapons. But they most likely will be used more freely once the initial use has been authorized. Threat forces consider chemical weapons as an extension of conventional warfare. If units understand the uses of chemical agents, they will be better able to avoid chemical hazards.

### Types of Chemical Agents

Chemical agents may be classified persistent, nonpersistent and dusty. Threat forces classify chemical agents according to their effect on the body. They identify six major types—nerve, blood, blister, choking, psychochemical, and irritants.

#### Persistent

Threat forces are known to stockpile persistent and nonpersistent agents.

Persistent agents are used to impede the use of critical terrain, channelize the attacking force, or contaminate materiel. Persistent chemical agents are used to produce casualties (immediate or delayed). Immediate casualties occur when the soldier inhales the vapor. Delayed casualties occur and is absorbed through the skin demonstrating the need for protective equipment.

Persistent agents are used to—

- Contaminate rear area supply depots.
- Defend avenues of approach.
- Neutralize personnel defending a strong point.
- Protect flanks.
- Degrade unit efficiency,

To avoid persistent agents-

Avoid areas heavily splashed with liquid contamination which may be persistent for several days (depending on weather and type of agent). See FM 3-6 for more details.

- Cover personnel, equipment, and supplies whenever possible.
- Monitor for the chemical agent for 2 to 10 days (depending on weather and type of agent). See FM 3-6 for more details.
- Concentrate on finding clean areas and routes (recon units).
- Cross contaminated areas in MOPP 4.
- Mark contaminated areas.
- Avoid contact with unknown liquids.

#### Nonpersistent

Threat forces currently stockpile blood agents, choking agents, psychochemical agents and nerve agents such as Tabun (GA), Sarin (GB), and Soman (GD). Although G-series nerve agents (GA, GB, GD and GF) are classified as nonpersistent agents, some G agents may persist for hours to days. Refer to Table 1-2 in Chapter 1 of this Field Manual or FM 3-4 for persistency data. Nonpersistent agents should be expected along the forward line of troops (FLOT), and against units in contact with the attacking echelon. These agents are used to immobilize, injure, or hinder activities of the unit under attack. For example, threat may use a blood agent at a critical moment in battle to force troops into a higher MOPP level. Forcing troops into a higher MOPP level reduces morale and degrades performance. Another advantage is that the threat would not need to decontaminate the area before occupying it. Nonpersistent agents act through the respiratory system or through skin absorption.

Nonpersistent agents are used to—

- Create favorable fighting conditions.
- Produce casualties prior to an assault.
- Degrade and suppress troops by forcing them into a higher MOPP level.

• Allow occupation without decontamination.

To avoid nonpersistent agents-

• Avoid low areas and enclosed spaces where vapors lingers.

- Camouflage
- Maintain discipline

## Dusty

Dusty agents, (toxic dust or dust-impregnated agents as they may be referred to) are not new. These agents have been subjected to extensive scientific research since the 1930's. These agents are primarily mustard (HD) and the nerve agent sarin (GB) impregnated onto a solid sorbent (usually on silica) and dispensed as aerosols. These agents generally have a lower vapor pressure and a dramatic increase in inhalation toxicity.

Vapors off gassing from the solid sorbent may be detected by the M256 Chemical Agent Detector Kit, Chemical Agent Monitor (CAM) or when mixed in water, by the M272 Water Test Kit.

## Detection and Identification

Following OPSEC measures, the next most important step in chemical contamination avoidance is detecting and locating chemical agents. Once agents are detected units can be warned to take appropriate protective measures, and can plan operations to minimize the effects of chemical agents. Detection allows individuals to survive and units to accomplish their missions.

Chemical agents will be delivered either directly on unit positions (on-target attacks) or upwind to drift over the unit position (off-target attacks). Detection methods differ for each type of attack.

On-target attacks produce immediate casualties by contaminating troops and equipment. If the attack is intended to produce immediate casualties, a large amount of agent must be delivered in a very short time (within 30 seconds). The M8 series alarm does not detect all chemical agents; it takes several seconds to respond to those agents it does detect. Therefore, a large percentage of troops might be exposed to chemical agents before the alarm sounds. As an example the M8 Alarm will sound within 2-3 minutes when exposed to a nonpersistent nerve agent concentration of GB at 0.2 mg/m<sup>3</sup> and persistent nerve agent VX at 0.4 mg/m<sup>3</sup>. The M8A1 alarm will sound within 1-2 minutes with an agent concentration of GB at 0.1 mg/m<sup>3</sup> and VX at 0.1 mg/m<sup>3</sup>. This means that troops must recognize the delivery of the chemical agent, observe a color change in the detector paper, or recognize symptoms of chemical agent poisoning.

Off-target attacks are easier to protect against. Units use the M8 series alarm to alert the unit that a chemical agent is about to drift over their position. Detector paper also can alert units that they are moving into a contaminated area. Protective action can then be taken before troops are exposed to the agent. Table 3-1 shows the arrival time of chemical agents for various wind speeds. A distance of 150 meters was chosen for the table

because it is the optimum distance that the detector can be placed upwind and a chemical agent cloud cannot slip behind the alarm and hit the unit.

Wind Speed (kmph)	Time Before Agent Reaches Unit Location (seconds)	Distance Between Unit and Detectors (meters)
5	108	150
10	54	150
15	36	150
20	27	150
25	22	150

When using this chart, commanders must realize that if the concentration of chemical agents is low, the alarm may not respond for several seconds. Also the average time for individuals to mask (including reaction time) is about 15 seconds. Warning times for different distances and wind speeds can be determined using the following formula—

$$\text{Warning time (see)} = \frac{\text{Distance (m)} \times 36}{\text{Wind speed (kmph)} \times 10}$$

36 is the factor to convert hours to seconds

10 is the factor to convert kilometers to meters

This method can be used only to warn against agents drifting into the unit location. On-target attacks circumvent detectors placed at this maximum distance.

## Automatic Chemical Agent Alarm

The automatic chemical agent alarm (ACAA) can be used in a stationary position. Keep the detector upwind at all times.

As soon as a unit arrives in an area it plans to occupy, it replaces the alarms. The detectors are always placed upwind. Unless circumstances do not permit, they should be no more than 150 meters upwind from the farthest upwind position of the unit. This warns the soldiers upwind as well as the soldiers farther downwind. The detector units should never be placed more than 400 meters from the alarm unit. Otherwise the signal may not be strong enough to sound the alarm. The optimum spacing of 300 meters between detectors reduces the risk that a chemical agent cloud will drift between detectors without sounding the alarm. The number of alarms needed to protect a unit depends on the unit size. The larger the unit front, the more detectors are needed to warn the unit. In this case, front means the upwind direction. Front could be the left or right flank or the forward or rear edge of the unit. Table 3-2 gives an estimate of the number of detectors needed for fixed employment of the alarms.

Table 3-2. Detectors required for different size unit fronts.	
Unit Front Size (meters)	Estimated Number of Detector Units
1-36	1
37-372	2
373-708	3
709-1044	4
1045-1380	5

Chemical alarms are usually employed at unit level. Exact positions for the alarms must be determined based on wind speed, wind direction, terrain, and tactical situation. The commander, with advice from the unit NBC NCO, will choose the actual positions. Figure 3-1 shows how a fixed emplacement might look. Note how the detectors are positioned and how these positions change when wind direction and unit position changes.

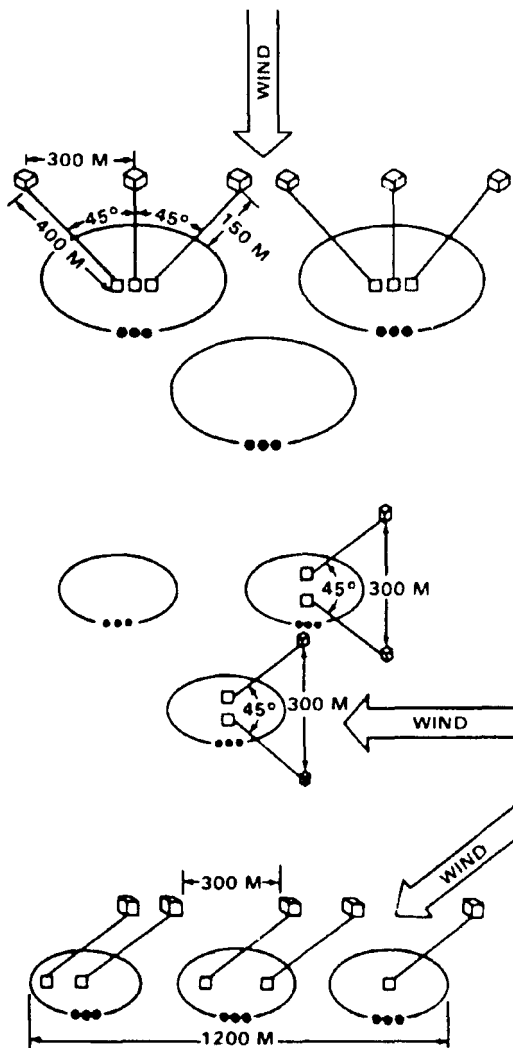

Figure 3-1. Fixed emplacement of ACAAs.

**NOTE**—When emplacement is completed for your element, you should show where the alarm's are by placing them on your range cards. For night operations a strip of engineer tape may be placed on the alarm so that they may be located.

When emplacing alarms, the wire connecting the alarm and detector must be protected from indirect fire. This can be done by burying the wire. The wire also should be checked periodically (at least once every four to six hours) to ensure it has not been broken or cut.

The M8 series alarm is designed to operate in a temperature range of -40°F to 120°F. During the war in the Persian Gulf deployed units experienced a high frequency of false alarms. This was due to a multitude of problems. However, the two principle causes were identified as the high temperatures the alarm was operating in and the dust concentration in the air. The high temperature problem was reduced by placing the alarm up off the ground on wood or boxes and placing the alarm in a shaded area either natural or manmade, such as under camouflage netting. High dust concentrations required replacing filter paddles in the alarm more frequently (1 every 1-2 hours of operation).

Since most units do not have many alarms, do not leave them behind. Ensure alarms are listed on vehicle load plans. The company chemical NCO, who controls placing and moving the alarm must ensure the unit personnel know when to retrieve the alarm. This is best done by making an alarm range card similar to a mine field range card.

The vehicular mode is only for the use of the vehicle's power supply. The backpack configuration is for small unit dismounted operations to facilitate transport. At no time should the M8 alarm be operated while moving. However, once vehicle brackets for newer vehicles become available (HUMMWV, M2, M1) the M8A1 alarm may be used on the move. M8A1 alarms may also be placed on helicopters while in flight but these alarms must operate on battery power.

### Chemical Agent Monitor

CAM, Figure 3-2, is a vapor monitor and can only report conditions at the front of the nozzle assembly. It is a point monitor only and cannot give a realistic assessment of the vapor hazard over an area from one position. It is necessary to move the CAM around the area carrying out a complete reconnaissance if a proper assessment is to be made of the vapor hazard in the area. When conducting reconnaissance with the CAM in a windy area, (such as on board ship, ground surface winds at 8 kmph or higher) use a funnel, paper cone or a can with a hole punched in it the size of the CAM probe.

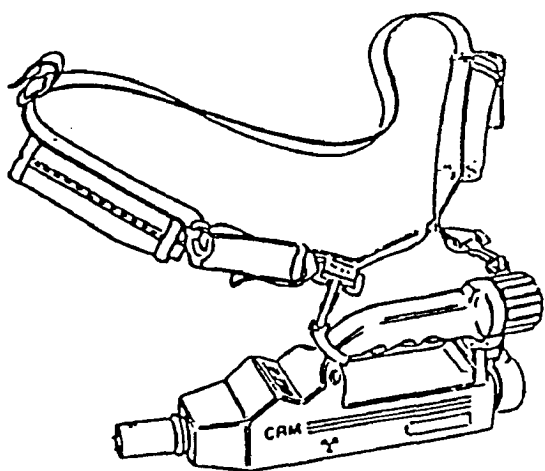

Figure 3-2. Chemical Agent Monitor.

(Any assessment will probably be made in conjunction with other detection methods).

**NOTE** If there is a source of vibration in the area, WAIT may be displayed momentarily when searching for agent. This is especially true when the CAM is used on board aircraft while in flight.

There are a few vapors present in the atmosphere that can, in some circumstances, give a false response in CAM. The situations most likely to give a false response are in enclosed spaces or when sampling near strong vapor sources (dense smoke). Some of the types of vapors that have been found to give false readings are given below:

- Aromatic vapors. Included in this category are groups of materials such as perfumes and food flavorings. Some brands of after shave and perfume can give a response in G mode when CAM is held close to the skin, for example as in casualty handling procedures. Some sweets such as peppermints and cough lozenges and menthol cigarettes can cause a response in G mode if the breath is exhaled directly into the CAM inlet.

- Cleaning compounds. Some cleaning compounds and disinfectants contain additives which give them a pleasant smell. Some of these additives such as menthol and methyl saticylate (MS) can give false responses in the H mode. Ammonia gives a false response in the G-mode. Cleaning materials are, by nature, spread over large surface areas and, therefore, provide a considerable vapor source, particularly in enclosed spaces.

- Smoke and fumes. The exhaust from some rocket motors and the fumes from some munitions can give responses. Since monitoring with CAM in these situations is unrealistic, few problems should arise. Additional interferents are listed in Table 32-a.

If CAM is suspected of giving a false reading:

- Stay masked.

Table 3-2. Common Interferents for the CAM.

Interferent	G Bar Response	H Bar Response
M258AI decon kit		High
W80 DKIE		High
DS2	Low	
Insect repellent	Low-Very High	
Brake fluid	High-Very High	Very High
Cleaner, general purpose	High	
Burning kerosene		High
Breath mints	High	
Gasoline vapor	Low	Low
Burning grass	Low-High	Low
Burning gas	Low	
Green smoke	Low	Low-High

- Check for obvious vapor sources, and known interferents.
- Remove and discard the filtered nozzle standoff and place the nozzle protective cap assembly onto the front of CAM case and re-establish a clear air background.
- Remove nozzle protective cap assembly and add a new filter. If false response reoccurs, CAM may not be operable in the immediate area. Remove source of interferent (if possible) or replace nozzle protective cap assembly and remove CAM from area.

When investigating the contamination of a person, object, vehicle, aircraft or piece of equipment, it is essential to first establish what general vapor hazard exists around the suspected contaminated equipment. If a reading higher than the background level is obtained, then the equipment is contaminated. If the reading is the same as the background, then it may be contaminated or the CAM may merely be recording the background vapor hazard. Care must be taken when assessing the contamination of an object from the information indicated on the CAM display. CAM display bars and corresponding warning are depicted in Figure 3-3.

The CAM is used to search out clean areas, to search and locate contamination on personnel, equipment, ship's structures, buildings and terrain, structures, aircraft and land vehicles, buildings and terrain, and to monitor the effectiveness of decontamination. CAM can also be used for monitoring collective protection shelters and the chemical contamination of aircraft while in flight. The Chemical Agent Monitor responds to nerve and blister agent vapors down to the lowest concentrations that could affect personnel over a short period.

The CAM has two operating modes, selectable by means of the G H mode pushbutton switch. In the G mode, CAM monitors for G-series nerve agents as low as

0.03 mg/m<sup>3</sup>; V-series nerve agent as low as 0.01 mg/m<sup>3</sup>, both within 1 minute. In the H mode, CAM monitors for blister agents as low as 0.01 mg/m<sup>3</sup> within one minute. The selected mode is indicated on the display assembly by a G or H. An ON/OFF pushbutton switch applies 6 VDC battery power to the CAM. A nozzle protective cap assembly contains material to clean the air within the CAM; the cap assembly is located in the front of the CAM whenever the CAM is not being used to monitor for contamination. Additional information on the operation of the CAM may be obtained from TC 3-4 or appropriate TM.

1 bar	Masking not required
2-3 bars	30 minutes unmasking in 24 hours if operationally essential.
4-6 bars	Remain in protective posture and note changing display and amount of agent.
6-8 bars	Do not unmask.

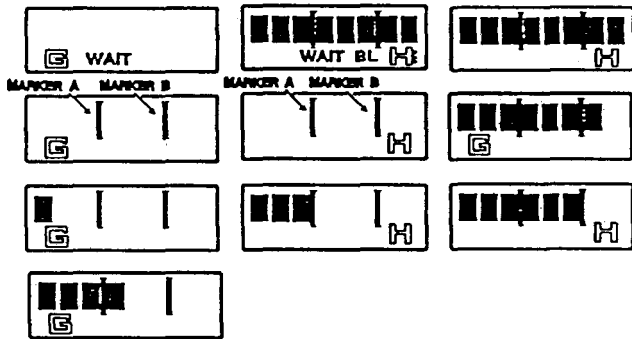

Figure 3-3. CAM Sensitivity Bars

**Individual Chemical Agent Detector (ICAD)**

The USMC issued ICAD (Figure 3-4) includes two electrochemical sensors, each of which is covered by a thin diffusion membrane. One sensor is sensitive to nerve agents (GA, GB, GD 0.5 mg/m<sup>3</sup> in 120 seconds), blood agents (AC, 250 mg/m<sup>3</sup> in 120 seconds), and choking agents (CG 25.0 mg/m<sup>3</sup> in 15 seconds); the other sensor detects blister agents (H, L 10.0 mg/m<sup>3</sup> in x seconds). Chemical agents in the air diffuse through the membranes on the faces of the ICAD sensors, and are collected by the electrolyte behind the membranes. The chemical agent concentrations in the electrolyte are measured by multiple-electrode electrochemical sensor systems. When the concentration reaches a preset threshold level, an audio alarm sounds and a light-emitting diode (LED) comes on.

During normal operation, especially in dusty or dirty environments, the ICAD may require external cleaning. To remove external dust or dirt, remove the sensor module from the electronics/ alarm module. Cover the connectors with your fingertips. With the connectors up, flush the sensor module with clean water, and then gently shake excess water from the unit. With the LED indicators and audio alarm up, flush the electronics/ alarm module with clean water, and then gently shake excess water from the unit. Do not use soap or any cleaning solution on the ICAD. Do not scrub or wipe the sensor membranes.

The normal operating temperature range of the ICAD is 0 to 113 degrees F (-18 to 45 degrees C). The ICAD can be stored prior to activation at temperatures ranging from 40 to 150 degrees F (-40 to 65 degrees C).



Figure 3-4. Individual Chemical Agent Detector (ICAD).

**CAUTION**

Do not store or operate the ICAD at temperatures below or above the specified temperature ranges. The ICAD could be permanently damaged.

**ABC-M8 Chemical Agent Detector Paper**

ABC-M8 Chemical Agent Detector Paper detects liquid chemical agents. It is used whenever chemical agents are suspected. Every soldier carries a booklet of ABC-M8 Paper in the mask carrier. Each booklet contains 25 sheets of paper. This paper turns colors when the paper touches a chemical agent. V-type nerve agent turns the paper dark green, G-type nerve agent turns it yellow, and a blister agent turns it red.

Night operations cause problems when using ABC-M8 Paper. The paper must be read in white light. Since

ABC-M8 Paper is used to check suspected areas for contamination, it can be brought into a white light area for reading. During night recon operations, the monitor can take several marked samples, then bring them back to the vehicle for reading. The paper is used by blotting it on the suspected contaminated surface. Do not rub the ABC-M8 Paper against the surface because false positive (red) streaks are produced.

### M9 Chemical Agent Detector Paper

Chemical Agent Detector Paper, M9 is the most widely used method of detecting liquid chemical agents. It is more sensitive and reacts more rapidly than ABC-M8 Paper. M9 Paper reacts to chemical agents by turning a red or reddish brown color. Place the M9 detector paper to opposite sides of the body. If you are right handed, place a strip of M9 paper around your right upper arm, left wrist, and right ankle. If you are left handed, place the M9 paper around your left upper arm, right wrist, and left ankle. It is also attached to large pieces of equipment (eg: conditioning systems, shelter or van entrances or vehicles). When attached to equipment it must be placed in an area free from dirt, grease, and oil. This is especially important since petroleum products and DS2 also cause the paper to change color.

M9 Paper is especially useful in detecting on-target attacks and keeping soldiers from entering contaminated areas. Whenever pink, red, reddish brown, or purple color appears on the paper, suspect the presence of chemical agents. As soon as M9 Paper indicates the presence of chemical agents, soldiers and units must take protective action to keep from becoming grossly contaminated. The results of the M9 paper should be confirmed with the M256 kit.

Night operations present some problems when using M9 Paper. Color changes will not show up when a flashlight with a red filter is used to read the paper. White light must be used. This could cause some serious OPSEC problems, especially for frontline troops. Commanders must realize that there is a risk if they do not establish procedures for checking M9 Paper for color changes. Soldiers can be rotated into a white light area or the M9 Paper can be collected periodically for reading.

### M256 Series Chemical Agent Detector Kit

The M256 series Chemical Agent Detector Kit is capable of detecting both liquid and vapor concentrations of chemical agents. It detects chemical agents in the following concentrations-nerve (G series; 0.005 mg/m<sup>3</sup> VX; 0.02 mg/m<sup>3</sup> within 15 minutes), blister (H; 2 mg/m<sup>3</sup> 12 mg/m<sup>3</sup> within 10 minutes), and blood agents (AC; 7 mg/m<sup>3</sup> within 10 minutes). The M256 Kit is issued at squad level, so every squad has the capability of detecting

and classifying chemical agents. The M256 series contains ABC-MS Chemical Agent Detector Paper for liquids and samplers/detectors for vapors. An improved M256 Detector Kit will also be capable of detecting T2 mycotoxin.

M256 series samplers/detectors are used primarily to determine the type of chemical agents present. A unit may have noticed an attack or the alarm may have sounded. The M256 series is then used to check if there is a chemical agent present and to identify the agent.

The M256 series also causes OPSEC problems during hours of limited visibility. A white light is needed to read both the ABC-M8 Paper and the sampler/detector. The light must be shielded from enemy observation. This can be done by using a pancho or other suitable covering.

### M272 Water Testing Kit. Chemical Agents

The M272 Water Testing Kit, Figure 3-5) Chemical Agents is a lightweight portable kit that will detect and identify harmful amounts of chemical warfare agents when present in raw and treated water. The kit will detect cyanide (AC) to 20 mg/liter, mustard (HD) to 2.0 mg/liter, lewisite (L) to 2.0 mg/liter and nerve agents (both G and V series) to 0.02 mg/liter. Water containing agents in less than these concentrations is permissible for short term (up to 7-day) use, in cold or warm regions with up to 5 quarts per person per day usage. These kits are usually found in chemical reconnaissance units, medical units and units with water purification or transportation missions.

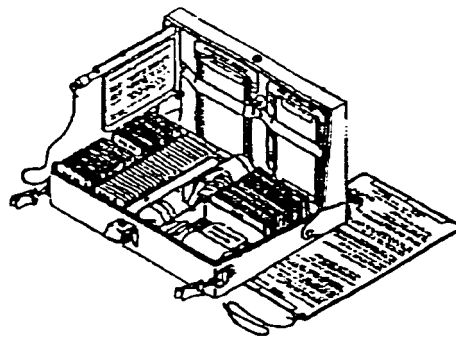

Figure 3-5. M272 Water testing kit, chemical agents.

### FOX, XM93, NBC Reconnaissance System (NBCRS)

The FOX (Figure 3-6) is a fully integrated NBC reconnaissance system with the following characteristics and operational capabilities.

Six wheel, amphibious armored cargo and tactical transport vehicle powered by a V8 diesel engine (320 horse power). The maximum speed is 65 miles per hour with a cruising range of 500 miles. It weighs 18.7 tons combat loaded and 16.9 tons without the crew and ammunition. It is equipped with a 40mm smoke grenade launcher and an M240E1, 7.62mm machine gun. The FOX is also equipped with a collective protection system which keeps the crew's working area free from contamination.

The integrated NBC defense/detection system has four key components.

- Mobile Mass Spectrometer (MM1)—Consists of a detection membrane probe system with an air/ground probe, and a rugged microprocessor. The system can monitor and identify all known chemical agents.

- Radiac Equipment (ASGI)—Consists of two probes installed in the exterior ports on each side of the vehicle connected to the radiation detection, identification, and computation instrument/recorder inside the vehicle.

- Vehicle Orientation System (VOS-25)—Operates through the principles of gyroscopic motion with a motion sensor attached to the vehicles' transmission. The unit (VOS-25) is integrated with the radiation (ASGI) and the chemical detection (MM1) and can accommodate depiction of chemical and radiological contamination on the map with the push of a button.

- NBC marking equipment—The vehicle has an NBC Marking Kit with an air-lock (glove port) through which the NBC contamination marking buoys are positioned.

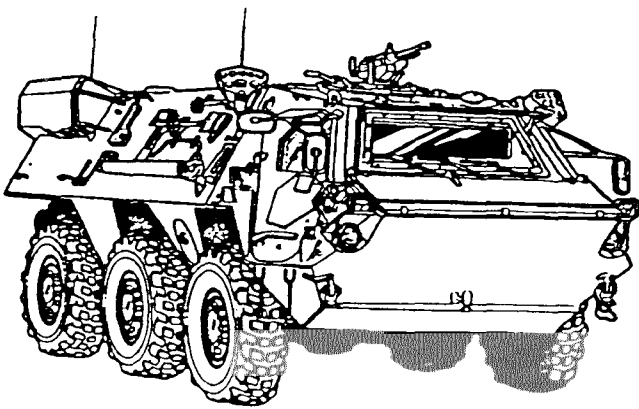

Figure 3-6. FOX, XM93, NBC reconnaissance system (NBCRS).

The FOX has nuclear, chemical and biological sampling equipment that consists of—

- A sample collecting device with transport container.
- Glove (rubber) protection for collecting samples

The equipment is fixed outside the vehicle and is operated manually using the glove and glove port device.

The FOX is also protected against electromagnetic pulse (EMP), transi-radiation effects on electronics (TREE), and electronic countermeasure (ECM).

The FOX system is assigned to the following units.

- Heavy Division (NBC recon platoon) has six (6) vehicles.

- Armored Cavalry Regiment (ACR) has six (6) vehicles.

- Motorized Brigade has six (6) vehicles.

**NOTE—The FOX system will also be assigned to the NBC reconnaissance chemical companies assigned to the TAACOM/CORPS when these companies are placed in active duty status. The TAACOM/CORPS units are projected to receive 36 systems each.**

Employment concepts—

- Offense—During offensive operations (such as movement to contact), the FOX NBCRS should be positioned well forward just behind the leading combat elements to facilitate contamination avoidance, responsiveness to reports of NBC contaminations, and to provide freedom of maneuver.

- Defense— During defensive operations, the FOX NBCRS should be used to conduct NBC reconnaissance operations in the rear areas to ensure that the routes to and from the corps, brigade, and division support areas are free of NBC contamination. The FOX systems are also used to find clean fall back positions for the fighting forces during withdrawal and retrograde operations.

### Remote Sensing Chemical Agent Alarm XM21 (RSCAAL)

This joint service system is a passive infrared spectroradiometer that uses an on-board microprocessor to detect and identify agent clouds. It operates by viewing a background scene (sky, terrain, buildings, etc.) and the airpath along its line of sight. When agent cloud enters the line of sight the new spectral information is compared to the stored background information and the specific infrared emission characteristics of a known agent. The detector scans along a 60-degree horizontal arc through seven 1.5 degree windows, the centers of which are 10 degrees apart. One scanning cycle (60-degree arc) takes less than 60 seconds. The detector has seven scan position lights that indicate which field of view (FOV) an agent cloud occupies. This allows the operator to determine an azimuth direction to the cloud and obtain an indication of



horizontal movement. The XM21 is designed to operate within the temperature range of -25° to 120°F.

The XM21 can perform the basic missions of reconnaissance and point or area surveillance. Employment of the XM21 must be tailored to fit the tactical situation and the capabilities of the detector. Common missions for the detector are—scan a defensive front, vector battlefield assets, monitor barriers and obstacles, monitor avenues of approach, and search areas between and adjacent to enemy and friendly forces.

The selection of general sites requires a map reconnaissance of the area of operations. Personal reconnaissance may be carried out when the tactical situation permits. This technique is especially useful when the XM21 is used in the area surveillance mission where the M8A1 system is being replaced or augmented. When selecting specific positions for the system, the team leader conducts a full reconnaissance of the general site. Selection of the specific site must take into consideration the line of sight limitation of the XM21. When the situation permits, terrain profiles may be requested from the G2 to ensure line of sight to the target area.

- A properly emplaced XM21 will detect significant G-agent, HD, and Lewisite munitions events and resulting clouds at ranges out to 5km with a greater than 85 percent probability of detection. Other features include:

- Stand-off detection for G-agents, HD-mustard, and L-blister agent clouds. Concentration sensitivity levels are recorded as CT = concentration x time. For nerve agents this sensitivity level is recorded as 3 mg - min/m<sup>3</sup> and for blister this level is 150 mg - min/m<sup>3</sup>.

- Operates under normal conditions without degradation at night.

- To set-up in the tripod mode by two trained personnel takes 10 minutes.

**Limitations.**

- Requires line of sight. Must be leveled and sighted to the terrain to maximize detection probability.

- Performance degraded by heavy rain, snow, dense foliage, and strong winds.

- System must be stationary to operate.

- A false alarm may occur when subjected to low angle direct sunlight on the optical window.

- Does not detect blood agents.

- Does not detect residual vapor hazard from evaporating liquid persistent agents under normal conditions.

**Reporting**

When chemical agents are detected and/or identified, the unit must report this information immediately to higher headquarters. Below company level, this is done with a SPOT report. The company NBC defense team then puts the report in an NBC 1 format and forwards it to battalion. Figure 3-7 is a sample NBC 1 Chemical Report.

If the unit uses the data from it's own Chemical Downwind Message to report attacks, this weather information must also be reported on the NBC 1 Chemical Report. This is accomplished by including line items Yankee (Y) and Zulu Alpha (ZA) on the NBC 1 Chemical Report. If the attack is unconfirmed or agent unknown, line item Zulu Bravo (ZB) will be included in the report at battalion level. Line ZB is the remarks line in the NBCWRS. Battalion chemical staff will include remarks indicating what measures have been taken to confirm the attack.

By the time the attack is confirmed, the NBC 1 Report would already be at division level. In the event that the report was based on a false alarm, an NBC 3 Chemical Report will still be issued but will include line item ZB stating the strike serial number and the words "cancelled - false alarm".

Standard Format	USMTF Format
NBC 1 Chemical	MSGID/NBC//
B LB200300	NBCEVENT/CHEMICAL//
D 200945Z	BRAVO/21RLB200300//
E 200950Z	DELTA/200945Z//
	ECHO/200950Z//
F LB200300 EST	FOXTROT/E/21RLB200300//
	GOLF/Artillery//
G Artillery	HOTELBC/Blister H/air//
H Blister H, Airburst	INDIA/5//
I (5 rounds)	

Figure 3-7. Sample NBC 1 Chemical Report.

**Data Evaluation**

Data evaluation consists of determining the attack location, confirming type of agent, means of delivery, type of attack, and assigning a strike serial number for each attack. Confirming the attack is critical, especially if it is the first reported chemical attack in the theater. Confirmation includes collecting samples of the suspected agent, obtaining pieces of shell or casing fragments, medical analysis of casualties (living or deceased), witness interviews and intelligence reports. Refer to Chapter 5 or FM 3-19 for detailed procedures on how to collect these samples. To confirm that a chemical attack has occurred, the M93 NBC reconnaissance vehicle should be dispatched to the area in question to take

samples. In the event that this vehicle is not available, units should take additional samples using 2 or more sampler detector tickets from two different M256 detector kits or by using additional ABC-M8 detector paper strips. In the event that an M8A1 alarm goes off, this would normally indicate that a nerve agent is present. If liquid droplets are not present in the area, this may indicate the presence of a G-series nerve agent or a vapor cloud from off gasing VX contamination. To determine what type of nerve agent is present, the M93 NBC Reconnaissance vehicle should be dispatched to the area concerned. This vehicle is capable of determining what type of nerve agent is present. In the event that this vehicle is not available, units must rely on the ABC-M8 Paper to determine whether G or V series nerve agent is present. The M256 kit sampler/detectors will not make this differentiation. This test may not provide the necessary information required if no liquid droplets are available. If the ABC-M8 paper test proves to be insufficient or indicates that a G nerve agent is present, units should rely on available intelligence information to determine what type of agent fill is available to the enemy. Compare this information with the means of delivery for the chemical agent attack to determine the extent and duration of the hazard area. If units are still unable to determine what type of G series nerve is present, assume worst case, Type A Case b. The NBCC plots all NBC 1 Reports and consolidates data pertaining to each attack. From this data, the NBCC prepares the NBC 2 Report and assigns a strike serial number. A record of these numbers is kept in the strike serial log. Figure 3-8 is a sample NBC 2 Report. A suggested format for a log is shown in Figure 3-9.

## Chemical Downwind Message

The Chemical Downwind Message (CDM) contains all the weather information needed to calculate a chemical downwind hazard. The CDM is useful because it provides the local wind speed, wind direction, stability category, and relative humidity in a short concise statement. It is prepared by corps and division NBCCS from information obtained through the US Air Force Air Weather Service (AWS), Staff Weather Officer, or the Fleet Weather Service.

The CDM is issued every six hours and is valid for three consecutive two-hour periods. It contains the following—

- Date-time group of the observation.
- Date-time group for basic data is the time the first forecast is effective. Adding two and four hours to this time gives the effective times for the other two forecasts.
- Area of validity is the area affected by the CDM. It could be a map sheet number or an area, such as division or corps.
- Air stability category describes the projected air stability. It will be one of seven numbers which correspond to stable, neutral, or unstable conditions.

Standard Format	USMTF Format
NBC 2 Chemical	MSGID/NBC2//
A C001 D 200945Z F LB200300 EST G Artillery H Nerve, Airburst Y 0130 Deg. 012 kmph ZA 412632	NBCEVENT/CHEMICAL// ALPHA/C001// DELTA/200945Z// FOXTROT/E/15RLB200300// GOLF/Artillery// HOTELBC/Nerve/air// YANKEEBC/0130DEG/012 Kmph ZULUA/4/12/6/3/2//

Figure 3-8. Sample NBC 2 Chemical Report.

Strike Serial Number (A)	Date/Time of ATK (ZULU) (D)	GZ Coordinates (ACT/EST) (F)	Kind of Attack (G)	Type of Agent (H)	Remarks
C001	200945Z	LB200300 EST	Arty	Nerve, Air.	

Figure 3-9. Suggested format for a chemical/biological strike serial log.

- Surface air temperature is the average temperature of the air in the forecast area.
- Surface wind speed and direction are the representative wind speed and direction during the forecast period.
- Relative humidity is the average humidity for the forecast period.
- Significant weather phenomena refers to any weather conditions that could affect either the distance the cloud travels or the duration of the agent in the hazard area
- Cloud cover in the area of validity.

## Preparing the Chemical Downwind Message

Division NBCC is usually the lowest level that prepares a Chemical Downwind Message. Separate brigades also may be required to prepare a CDM when operating independently. Figure 3-10 is a sample CDM.

The first step in preparing the CDM is to acquire the weather data. The Air Weather Service (AWS) is the best source for this information. They provide weather forecasts for division or corps areas. Weather information can also be obtained from the artillery meteorological section. Although they cannot provide forecasts, they can provide current weather information.

The next step is to break it down into three consecutive two-hour increments. Line Whiskey Mike is used for the first two-hour increment, line X-ray Mike for the second, and line Yankee Mike for the final two-hour increment. Then the NBCC translates this data into codes and puts it in the proper format. Each forecast line contains 12 digits.

The first six digits represent the downwind direction and wind speed. The last six digits represent the air stability, temperature, humidity, significant weather phenomena, and cloud cover (see Figure 3-11). Weather data which is unavailable or for which no code exists is represented by a dash.

A valid CDM may not always be available from the corps or division NBCC or applicable to the unit area of

Standard Format	USMTF Format
CDM	CDM
110500Z 110600Z I Corps WM 120010418742 XM 125019416742 YM 130005518642	MSGID/CDM// OBSTIME/110500Z// FCSTIME/110600ZMAR83// IIXAREA/ CORPS// FVALUE/WM/120/010/4/18/7/4/2// FVALUE/XM/125/019/4/16/7/4/2// FVALUE/YM/130/005/5/18/6/4/2//

Figure 3-10. Example of Chemical Downwind Message.

operations. Units may estimate the air stability category by observing local meteorological conditions. A field expedient method of obtaining the necessary weather data may be used when all other sources are unavailable. In order to obtain local weather data, units may obtain a Belt Weather Kit (NSN—6660-01-024-2638) and barometer (NSN—660-00-551-3998) or use the equipment listed below. The weather information obtained in this manner is only for that particular area. for that period of time. It is by no means, a forecast from which a CDM maybe produced. However, it is a local method of verifying CDM weather data. If this method is used for local weather, include this data on the NBC 1 Chemical Report.

- M1 Ananometer (66000663-8090)
- Wet Bulb, Globe, Temp (C°) (6665-00-159-2218)
- Lensatic Compass

**Step 1.** Measure windspeed and direction with the lensatic compass and ananometer. Use the highest

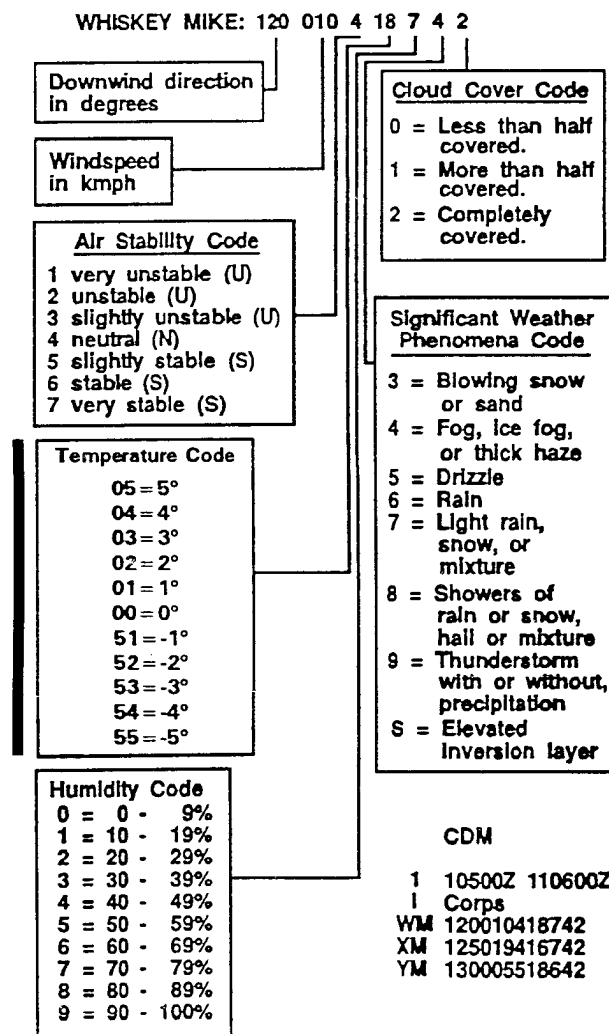

Figure 3-11. Coded weather information in a Chemical Downwind Message.

windspeed recorded. Take temperature and humidity readings using the wet bulb at one meter above the ground. Obtain readings every two hours if practical, but not greater than four hours.

**Step 2.** Determine the four transition periods of windspeed and direction during the day. Take average of the readings during each transition period.

The most difficult aspect is determining the sun by observation. Since most units do not have equipment to do this, make the best estimation possible.

**Example**—It is morning. The sun's angle is 45 degrees, and the sky is less than half covered. Find the time of day (morning) and angle of sun (45 degrees) on the chart at Table 3-3. Find the sky condition (less than half covered). Read across and down to the point where the lines converge. The air stability category is U.

## Atmospheric Stability Charts

The stability of a chemical or biological agent cloud is directly effected by the temperature of the air at the surface of the earth and the first few meters above the surface.

### Temperature Gradients

The air stability categories are dependent on the temperature gradient (difference of air temperature at two altitudes). The temperature gradient is determined by measuring the air temperature at two different altitudes.

Compare the difference in air temperature to the normal or expected change in temperature. The normal change in temperature is 1 degree cooler for every 100 meters increase in altitude. The four possible gradient conditions are inversion, neutral, lapse, and elevated inversion.

### Inversion Temperature Gradient (Stable-S).

If the air at the higher altitude is warmer than the normal temperature at the lower altitude, the air will not move vertically. This represents an inversion temperature gradient. This condition usually exists on a clear or partially clear night when middle and low clouds cover less than 30 percent of the sky, and on early mornings until about 1 hour after sunrise when the wind speed is less than 5 knots. It is characterized by a minimum of convection currents and by maximum air stability-ideal for enemy employment of chemical agents. Weak inversion conditions tend to prevail during the day over large bodies of water.

### Neutral Temperature Gradient.

A neutral condition exists when air temperature shows very little or no change with air increase in altitude. This represents the neutral temperature gradient. This condition usually exist on heavily overcast days or nights at 1 or 2 hours before sunset or 1 to 2 hours after sunrise when the middle and low clouds cover more than 30 percent of the sky. Independent of cloud cover and time of day, a neutral condition may also exist when the wind speed is greater than 5 knots. Additionally, periods of precipitation are normally accompanied by a neutral condition. A neutral temperature gradient is most favorable for enemy use of biological agents because the associated wind speeds result in larger area coverage.

### Lapse Temperature Gradient (Unstable-U).

If the air at the higher altitude is cooler than the expected difference, then there will be vertical movement of air creating turbulence. This condition normally exists on a clear day when the middle and low clouds cover less than 30 percent of the sky and when the wind speed is less than 5 knots. This is the least favorable condition for the enemy to employ chemical or biological agents. Over large bodies of water, weak lapse conditions tend to prevail at night. When a lapse condition exists, area coverage without diffusion will be enhanced with a steady low wind speed of 3 to 7 knots.

### Elevated Inversion (Stable).

*Table 3-3. Air stability category basic chart.*

Air Stability Category Basic Chart			
Time of Day* and Angle of Sun	Condition of Sky		
	Less Than Half-Covered	More than Half-Covered	Overcast
M O R N I N G	< 4°	S	S
	> 4° 32°	N	N
	> 32° 40°	U	N
	> 40°	U	N
E V E N I N G	> 46°	U	N
	> 35° 46°	U	N
	> 12° 35°	N	N
	> 5° 12°	S	N
	< 5°	S	N

Elevated inversion may occur when cooler air settles under warmer air. This condition will generally occur when a warm and cold frontal system converge or over large bodies of water. The significance of an elevated inversion layer is that the layer will act as a lid over the surface. This "lid" traps air particulates as well as chemical agents, in a concentrated form, at a given height above the ground, thus presenting an increased threat to aircrews. The Staff Weather Officer must report this condition, when it occurs to the NBCC and divisional aviation units.

Once you have obtained the air stability category from the basic chart, enter the adjustment chart with that category. Select the appropriate weather and terrain condition from Table 3-4. Read across to where they intersect and extract the final stability category. Use this stability category to determine the maximum downwind distance. For more information on field expedient behavior of chemical agents, see FM 3-6.

### Simplified Hazard Prediction

The simplified hazard prediction tells subordinate units whether they are in a chemical downwind hazard area. Since Type A attacks present the greatest hazard, the simplified procedures are based on that type of attack. It is valid until an NBC 3 Report is received from higher headquarters.

*Table 3-4. Air stability category adjustment chart.*

Air Stability Category Basic Chart Adjustment Chart			
Weather and Terrain All eight conditions given below must be checked. If more than one applies, choose the most stable category.	Stability Category From Basic Chart		
	U	N	S
Dry to slightly moist surface.	U	N	S
Wet surface (after continuous rain or dew).	N	N	S
Frozen surface or partly covered with snow, frost, or hoarfrost.	N	S	S
Surface completely covered with snow.	S	S	S
Continuous rainfall.	N	N	N
Haze or mist (visibility 1 to 4 km).	N	N	S
Fog (visibility less than 1 km).	N	S	S
Downwind speed more than 18 km.	N	N	N
U = Unstable N = Neutral S = Stable			

Units need to make a simplified prediction using a Chemical Downwind Message and a simplified template. The template can be made out of acetate, overlay paper, or plastic. Figure 3-12 shows a sample simplified predictor. The following steps show you how to use a simplified prediction.

**Step 1.** Get the wind speed from the CDM. If it is  $\leq 10$  kilometers per hour, use the circular portion of the prediction. If it is  $> 10$  kilometers per hour, follow the remaining steps.

**Step 2.** get the wind direction from the CDM. Mark that direction on the compass circle of the template.

**Step 3.** get the air stability code from the CDM; use this code (U, N, or S,) to determine the downwind distance.

**Step 4.** Place the template on the map with the attack center of the prediction (the cross mark) over the actual attack center. Rotate the predictor until the downwinds direction points toward GN.

**Step 5.** Draw the downwind line perpendicular to the downwind direction using distance obtained in step 3.

Means of delivery	Distance from center of attack area along downwind axis, when the air stability category is:		
	U	N	S
Artillery, Bomblets, and Mortars	10 KM	30 KM	50 KM
Multiple rocket launchers, missiles, bombs, and unknown munitions	15 KM	30 KM	50 KM

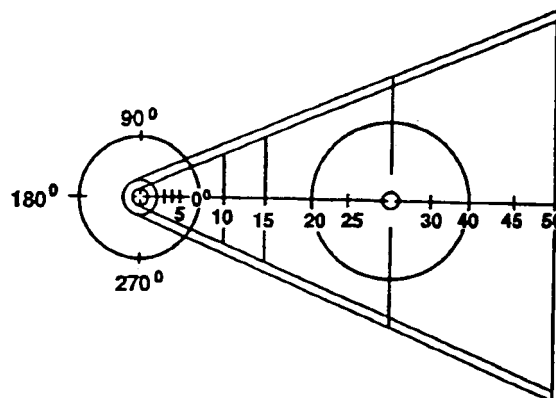

Figure 3-12. Area prediction, chemical downwind hazard.

### Duration of Agent

For ground contamination, the temperature is one of the major factors for determining how long the agent presents a vapor hazard. Refer to tables 3-6 through 3-17, in Chapter 3, FM 3-4, NBC protection. These charts cover duration of agents at different temperatures, which will allow the commander to determine when to start MOPP opening/unmasking procedures.

#### NOTES

1. These charts are worse care using a 500 pound bomb.
2. In making hazard estimates, vapor is the determining factor within the attack area as well as in the downwind hazard area. However, the duration of hazard from contact with bare skin is difficult to predict. Duration can only be determined by the use of chemical agent detection devices.
3. When temperatures are consistently low, the duration of ground contamination maybe Linger than indicated in the table. The absence of vapor does not preclude the presence of contamination.

## Chemical Downwind Hazard Prediction

The hazard from a chemical attack is not confined to the area directly attacked. The resulting vapor or aerosol travels with the wind and can cover a large area downwind of the attack area. To prevent casualties, you must quickly identify the possible hazard and warn units within the hazard area. This section provides instructions for defining the probable hazard area resulting from a chemical attack.

The prediction of the hazard areas is only an approximation. Terrain and weather, as well as delivery system variations, modify the hazard area. In addition, the methods used to predict the downwind hazard are safesided for troop safety. This assures that the hazard will be within the predicted area. This gives units in the area time to take appropriate precautions. These procedures are derived from STANAG 2103 and ATP-45 with change 1.

### Type of Attack

For hazard prediction, all attacks are classified as either Type A, air-contaminating agents or Type B, ground contaminating agents.

The prediction of downwind chemical hazard areas depends on the wind speed, temperature, and humidity; and for ground-contaminating agents-the size of the attack area.

### Air-Contaminating Agents-Type A

Type A agents are normally dispersed as an aerosol or vapor cloud with little or no ground contamination. A nonpersistent nerve agent employed upwind of the target. Air-contaminating agents are normally dispersed in ground-bursting munitions such as artillery shells and multiple rocket launchers. This type of attack is a Type A attack. Refer to flow chart on pages 3-13 thru 3-16.

### Ground-Contaminating Agents-Type B

Type B agents are normally dispersed in liquid form to contaminate surfaces. Persistent nerve and mustard agents are examples of this type of attack. Refer to flow charts on pages 3-13 thru 3-16.

Ground-contaminating agents are normally dispersed by aircraft spray tanks, air-bursting artillery shells, rockets, missiles, and mines. Evidence of ground contamination on may include the observer's report of agent falling to the ground from air-bursting munitions, identification of agent with ABC-M8 paper, positive response of M9 Paper, or the identification of blister agent with the M256 series sampler, or reading on the CAM.

To predict a downwind hazard area, whether the attack was a Type A or Type B, you need the following information

- An NBC 1 or NBC 2 Chemical Report.
- Detailed meteorological information Chemical Downwind Message (CDM) or similar information.

This information is then used to determine the appropriate procedure to predict the downwind hazard area. There are six cases that must be considered. Use the chart on the following page to determine which of the six procedures to use when constructing the downwind hazard prediction.

### Plotting the Downwind Hazard-Type A

Two cases must be considered when plotting the downwind hazard area from a Type A attack.

Case a wind speeds of 10 kmph or less.

Case b wind speeds greater than 10 kmph.

Type A, Case a (Figure 3-13, page 3-17) is for wind speeds of 10 kilometers per hour or less.

**Step 1.** Get the attack location from an NBC 1 or an NBC 2 chemical Report and plot the location on the map or template (preferably UTM scale 1:50,000).

**Step 2.** Draw a 1-kilometer-radius circle around the center of the attack location. The area within the circle represents the attack area.

**Step 3.** Draw a 10-kilometer-radius circle concentric with the 1-kilometer circle. The area within the circle represents the hazard area.

**Step 4.** Send an NBC 3 Chemical Report to

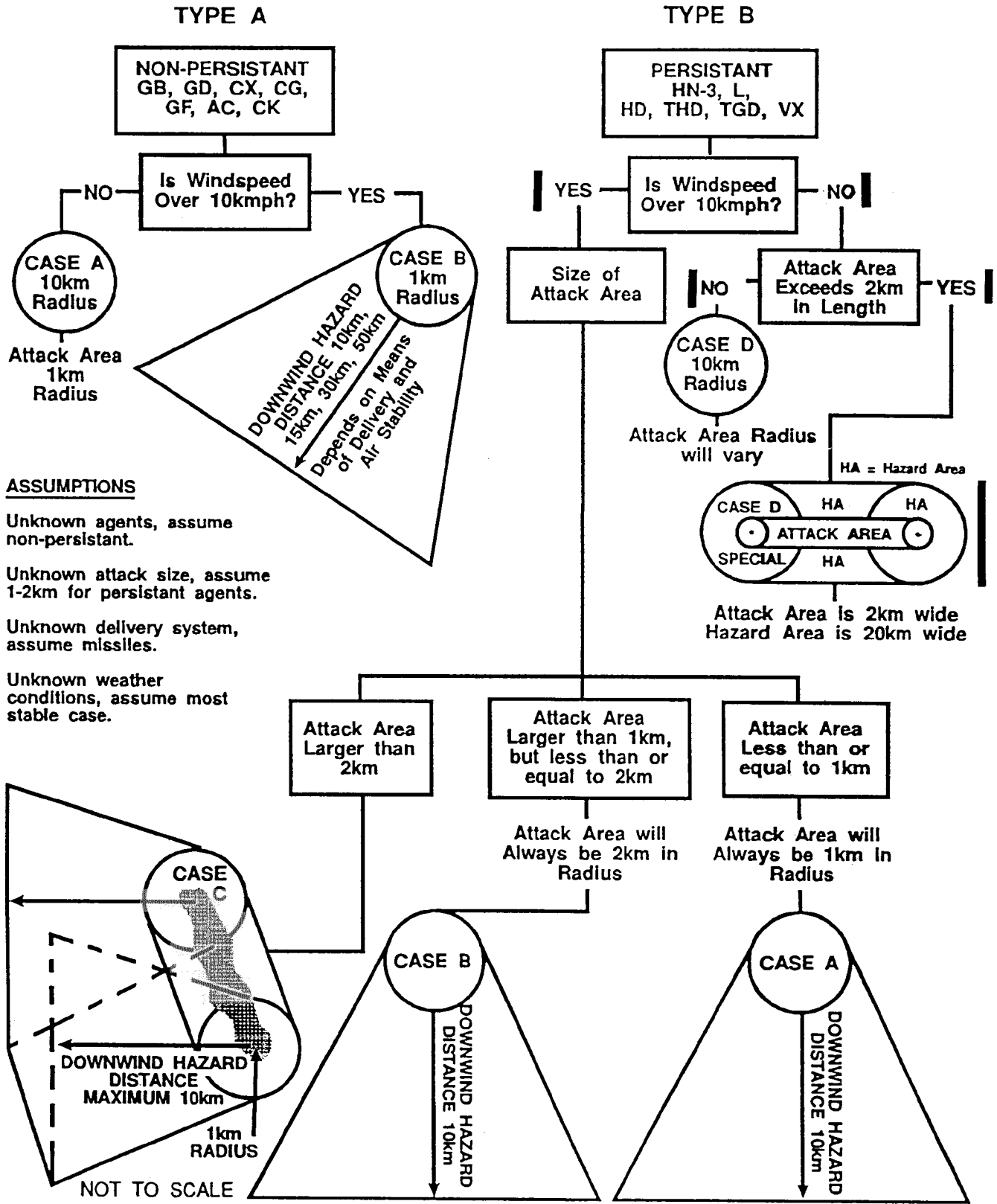

Not To Scale

Flow Chart

**TYPE B  
PERSISTANT**

**TYPE B CASE D  
SPECIAL**

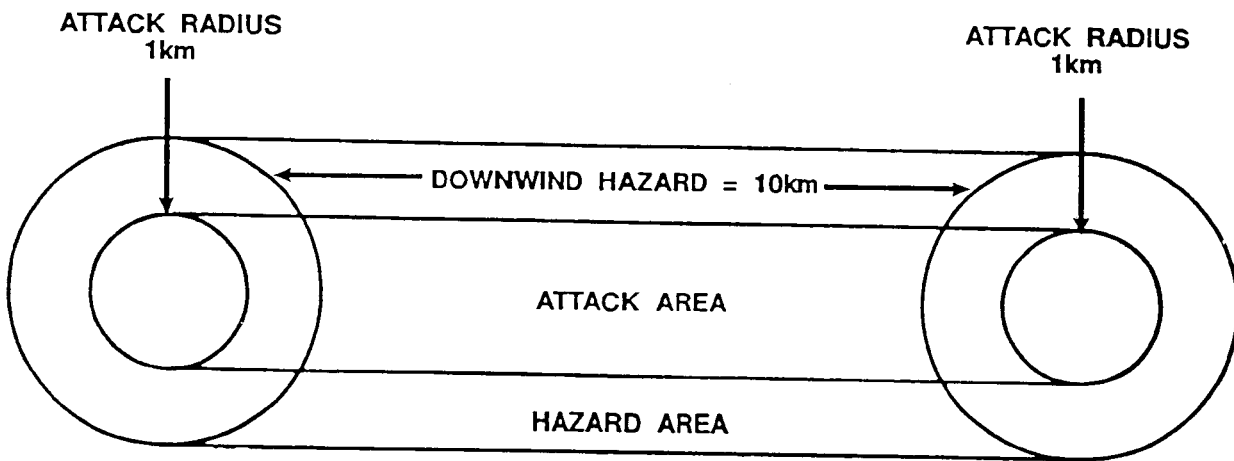

**NOTE:** When the windspeed is 10 kilometers per hour or less and you have a spray attack or large-scale artillery attack where the length of the attack area exceeds 2 km's, a 1 kilometer circle should be drawn around the start and end points. These circles should be connected on both the upwind and downwind sides to designate the attack area. Ten kilometer circles should be drawn around the start and end points and connected on the upwind and downwind sides to designate the hazard area (see plot above).

NOT TO SCALE

*Flow Chart*



**Chemical Hazard Prediction  
Ground Burst Non-Persistent Agent**

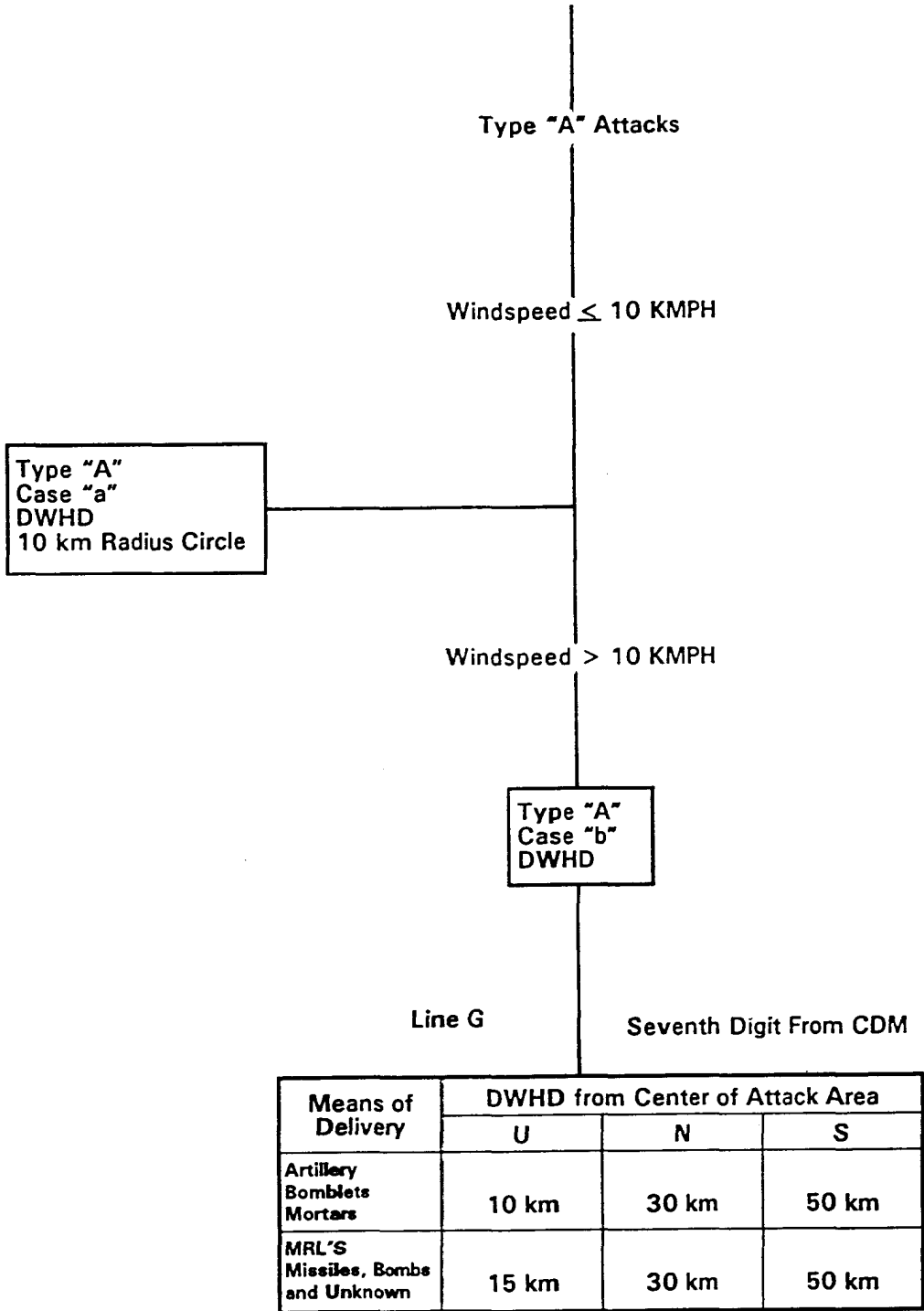

*Flow Chart*

**Chemical Hazard Prediction  
Air Burst Persistent Agent  
Type "B" Attack**

Windspeed  $\leq$  10 kmph

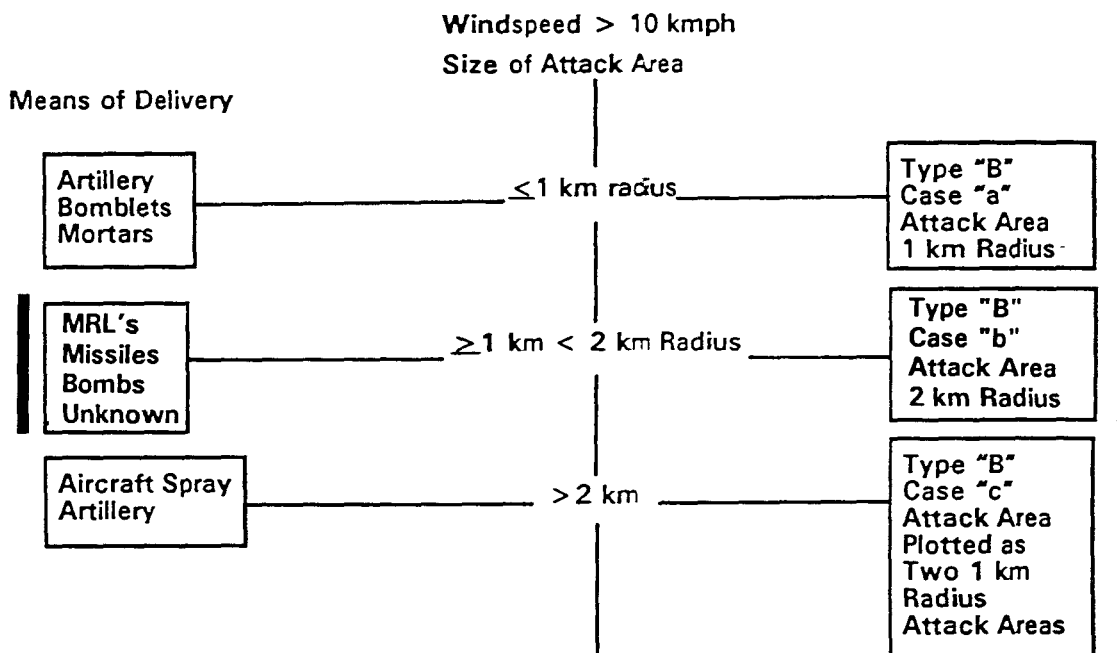
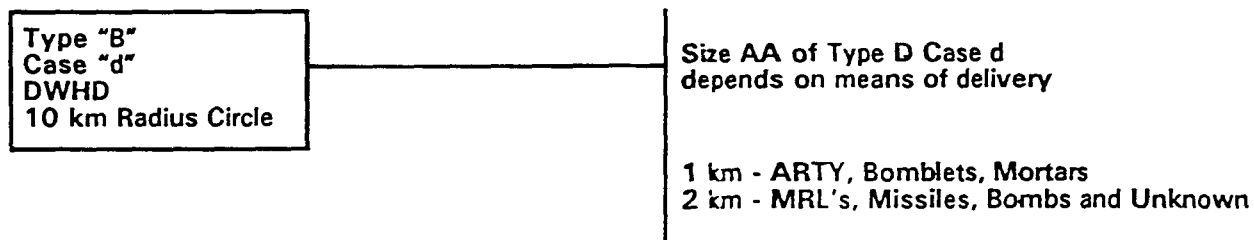

- \* All Type "B" Downwind Distance is 10 km
- \* Size of Attack Area Unknown, Use Type "B" Case "b"

Probable Time After Ground Contamination Which Personnel May Safely Remove Mask (Line Papa Bravo)		
Daily Mean Surface Air Temperature	Within Attack Area Number of Days	Within Hazard Area Number of Days
$< 0 - 10^{\circ} \text{C}$ (32 - 50 $^{\circ}$ F)	3 - 10 Days	2 - 6 Days
11 - 20 $^{\circ}$ C (51 - 68 $^{\circ}$ F)	2 - 4 Days	1 - 2 Days
21 - $> 30^{\circ}$ C (69 - 86 $^{\circ}$ F)	Up to 2 Days	Up to 1 Day

Flow Chart

units/installations in the hazard area (PA is 010).

Type A, Case b (Figure 3-14) is for wind speeds greater than 10 kilometers per hour.

**Step 1.** Get the attack location from an NBC 1 or an NBC 2 Chemical Report and plot the location on a map.

**Step 2.** Draw a GN line.

**Step 3.** Using the attack location as a center, draw a 1-kilometer-radius circle around the attack location.

**Step 4.** Obtain the downwind direction and speed from a valid CDM. Draw a line from the attack center representing the downwind direction.

**Step 5.** Find the appropriate air stability category and means of delivery in Table 3-5. Extract the maximum

downwind distance of the hazard area. Plot the maximum downwind distance and draw a line perpendicular to the downwind direction.

**Step 6.** Extend the downwind direction line upwind 2 kilometers from the attack center. From this point, draw two lines that just touch the attack area circle and extend them until they intersect the maximum downwind distance line.

**Step 7.** Send an NBC 3 Chemical Report to units/installations in the hazard area.

### Plotting the Downwind Hazard-Type B

Four cases must be considered when plotting the downwind hazard area for a type B attack. One case (Case d) is for wind speeds of 10 kilometers or less. The other three cases are for wind speeds of greater than 10 kilometers per hour. In all cases, the maximum downwind distance is 10 kilometers. Therefore, the air

Step 4  
Example (Type A, Case a)  
NBC 3 Chemical Report  
Step 3

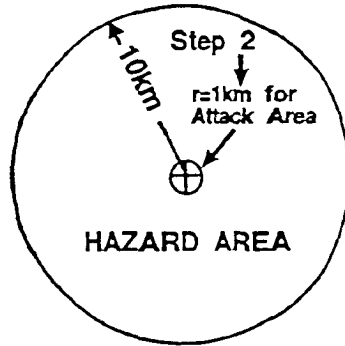

Figure 3-13. Plot for downwind hazard, Type A, Case a.

Means of Delivery	Distance from Center of Attack Area Along Downwind Axis, When the Air Stability Category is—		
	U	N	S
Artillery, Bomblets, and Mortars	10 km	30 km	50 km
Multiple Rocket Launchers, Missiles, Bombs, and Unknown Munitions	15 km	30 km	50 km

#### STEP 7

Example (Type A, Case b) NBC 3 Chemical Report

A 002  
D 2716472  
F LB560750 Actual  
H Nerve, NP, Ground Burst  
\*PA LB556751  
LB559754  
LB632774  
LB610694  
LB558747  
Y 0105 Deg, 022kmph  
ZA 218242  
ZB Type A Case B

• Coordinate points of line PA.

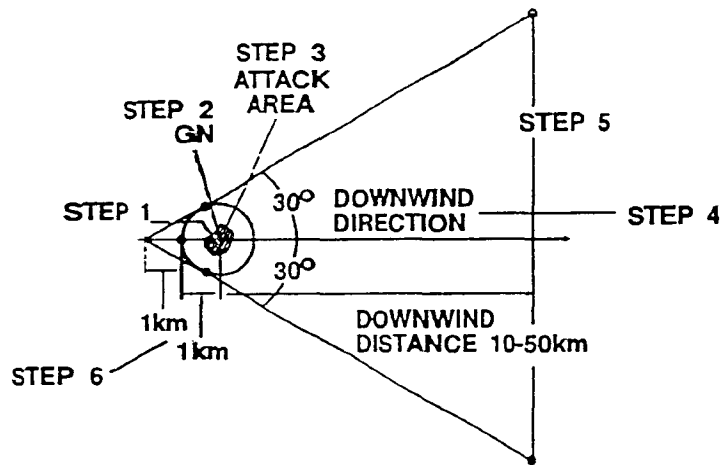

Figure 3-14. Plot for downwind hazard, Type A, Case b.

stability category does not need to be considered. The governing factor is the size of the contaminated area.

Three Type B cases have wind speeds greater than 10 kilometers per hour.

Case a (attack area  $\leq 1$  kilometer). Contamination is contained within a circular attack area of 1-kilometer radius. This most likely occurs after an artillery attack.

Case b (attack area  $> 1$  kilometer 2 kilometers). Contamination is contained within a circular attack area; the radius is greater than 1 kilometer, but less than or equal to 2 kilometers. This most likely occurs after a missile attack with a high airburst, for example, over 1,000 meters high.

Case c (length of attack  $> 2$  kilometers). Any dimension of the attack area exceeds 2 kilometers. This

most likely occurs after a spray attack or an artillery attack of several regiments.

**NOTE** —If you know the attack is a ground attack but do not know the extent of it, assume it to be a Type B, Case b, attack.

First, determine which case exists. Do this by plotting the actual attack location on a map, then determine which of the three cases it is.

Type B, Case a (Figure 3-15), occurs when the attack area is 1 kilometer or less. Plot the same as a Type A, Case b, attack; the single exception is that the maximum downwind distance is 10 kilometers.

Type B, Case b (Figure 3-16) occurs when the attack area is greater than 1 kilometer but less than or equal to 2 kilometers.

*Table 3-6. Downwind hazard cases.*

Type Attack*	Case	Attack Area**	Wind Speed	Downwind Hazard
Air (A)	a	1 km	$\leq 10$ kmph	10-km circle
	b	1 km	$> 10$ kmph	10, 15, 30, or 50 km***
Ground (B)	a	1 km	$> 10$ kmph	10 km
	b	1 km 2 km	$> 10$ kmph	10 km
	c	2 km distance	$> 10$ kmph	10 km
	d	same as case a, b, or c	$\leq 10$ kmph	10 km Circle

\*Assume all attacks to be Type A attacks unless there is unmistakable evidence of ground contamination.  
 \*\* if the size of the attack area is not known, assume the attack to be a Type B, Case b, attack.  
 \*\*\* Downwind hazard depends on the means of delivery and temperature gradient. (See table 3-5).

**Step 1.** Get the attack location from an NBC 1 or an NBC 2 Chemical Report and plot the location on a map.

**Step 2.** Draw a GN line.

**Step 3.** Using the attack location as a center, draw a 2-kilometer-radius circle around the attack location.

**Step 4.** Obtain the downwind direction and speed from a valid CDM. Draw a line from the attack center representing the downwind direction. Extend this line 10 kilometers downwind. Draw a line perpendicular to the downwind direction.

**Step 5.** Extend the downwind direction line upwind 4 kilometers from the stick center. From this point draw two lines which just touch the attack area circle and extend them until they intersect the maximum downwind distance line.

**Step 6.** Send an NBC 3 Chemical Report to Units/installations in the hazard area.

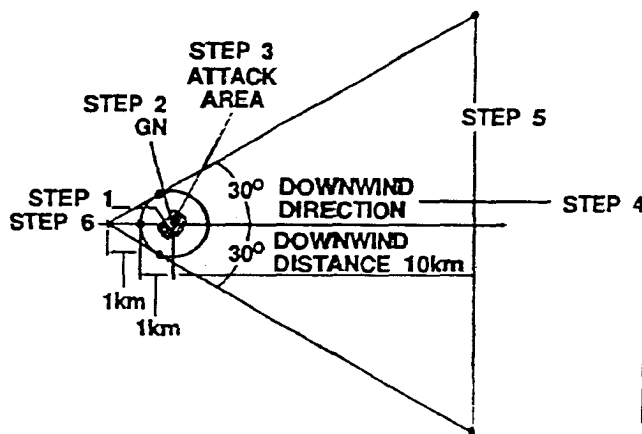

**STEP 7**

Example (Type B Case a) NBC 3 Chemical Report

- A 002
- D 271472
- F LB560750 Actual
- H Nerve, NP, Ground Burst
- PA LB556751  
LB559754  
LB632774  
LB610694  
LB558747
- PB In attack area up to 2 days  
In hazard area up to 1 day  
Nerve, P, Airburst
- Y 0105 Deg, 022 kmph
- ZA 218242
- ZB Type B Case A
- Coordinates points of line PA

Figure 3-15. Plot for downwind hazard, Type B Case a.

**STEP 6**

**Example (Type B Case b) NBC 3 Chemical Report**

A 002  
 D 27147Z  
 F LB560750 Actual  
 H Nerve, PER, Ground Burst  
 PA LB556751  
 LB559754  
 LB632774  
 LB106694  
 LB558747  
 Y 0105 Deg, 022 kmph  
 ZA 218242  
 ZB Type B Case b  
 • Coordinate Points For Lines PA

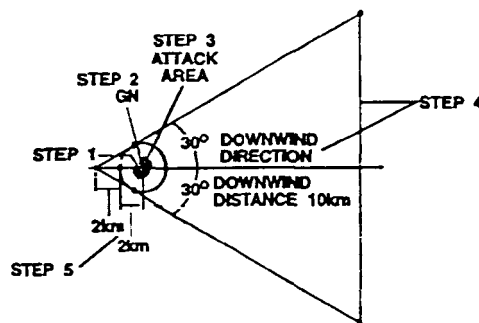

Figure 3-16. Plot for downwind hazard, Type B, Case b.

Type B, Case c (Figure 3-17) occurs when the attack area is greater than 2 kilometers.

**Step 1.** Plot the estimated attack area on the map and establish a point at each extreme end. Draw a GN line from one of the points.

**Step 2.** Draw a 1-kilometer-radius circle around each point.

**Step 3.** Draw a line tangent to both circles upwind of the attack area and a line tangent to both circles downwind of the attack area.

**Step 4.** Regard the two circles as being two separate attack areas and construct the two vapour hazard areas, as for a Type B, Case a.

**Step 5.** Draw a line from the point labelled "A" to the

point labelled "B", as shown Figure 3-17.

**Step 6.** Prepare an NBC 3 chemical Report and send it to units/installation within the hazard area.

Type B, Case d (Figure 3-18) is for wind speeds 10 kmph or less.

**Step 1.** Get the attack location from an NBC 1 or NBC 2 Chemical Report and plot the location on a map or template.

**Step 2.** Draw a 10-kilometer-radius circle around the attack area center.

**Step 3.** Draw the appropriate radius around the center of attack as per means of delivery.

**Step 4.** Send an NBC 3 Chemical Report to units/installations in the hazard area.

**STEP 6**

**Example (Type B, Case c) NBC 3 Chemical Report**

A 007  
 D 141550Z  
 F UC310060 to UC370061 est  
 H Nerve, V, Spray  
 PA UC313068  
 UC303068  
 UC298059  
 UC305938  
 UC365939  
 UC481014  
 UC290040  
 PB Attack Area 2-4 Days  
 Hazard Area 1-2 Days  
 In attack area up to 2 days  
 In Hazard area up to 1 day  
 Y 0147 Degrees,  
 012 kmph  
 ZA 216662  
 ZB • Coordinate Points For Line PA

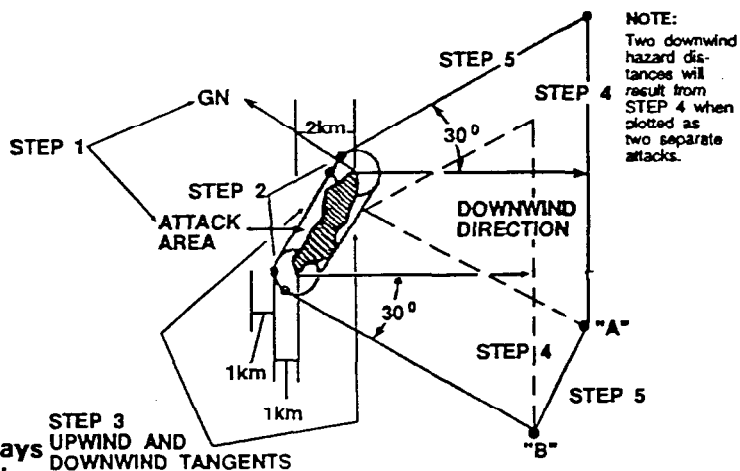

Figure 3-17. Plot for downwind hazard, Type B, Case c.

Type B, Case d (special) (Figure 3-19) is for winds speeds less than 10 kilometers per hour and you have a spray attack or large-scale artillery attack where the length of the attack area exceeds 2 kilometers.

**Step 1.** Get the attack location from the NBC 1 or NBC 2 Chemical Report and plot the location on the map or template.

**Step 2.** Draw a 1 kilometer radius circle around the start and end points.

**Step 3.** Connect both the upwind and downwind sides to designate the whole attack area.

**Step 4.** A ten kilometer circle should be drawn around both the start and end points of the attack.

**Step 5.** Connect both the upwind and downwind sides of the ten kilometer circles to designate the hazard area.

**Step 6.** Send an NBC 3 Chemical Report to Units/installations in the hazard area.

constant environmental conditions. When the weather changes, the NBC 3 Report may no longer apply. An adjusted NBC 3 Report must be sent to unit/installations in the new hazard area, if possible. Also notify units who may no longer be in the hazard area.

Significant weather changes are:

- Representative downwind speed of 10 kmph or more, or if the windspeed increases from less than 10 kmph to more than 10 kmph or the reverse.
- Air stability category (applies to type A attacks only).
- Downwind direction by 30 degrees or more.

For a **change in** wind speed determine the geographical center of the frontline of the traveling cloud at the time the new data becomes available. calculate this distance by multiplying the original wind speed times to twice the time in hours since the attack. The center of the cloud front is then considered to be the new center of attack area. Once the new center of attack is determined, the downwind hazard area is determined using the procedures outline for that type of attack.

## Adjusted Hazard Prediction

The methods previously discussed are based on

Example (Type B, Case d) NBC 3 Chemical report

A 005  
 D 220730Z  
 F LB212295 est  
 H Nerve, V, Airburst  
 PA 010 km  
 PB In attack area up to 2 days  
 In hazard area up to 1 day  
 Y 0105 deg, 008 kmph  
 ZA 219452  
 ZB Radius of Attack Area 1 km, Type B Case d

NOTE: Attack area radius depends on means of delivery

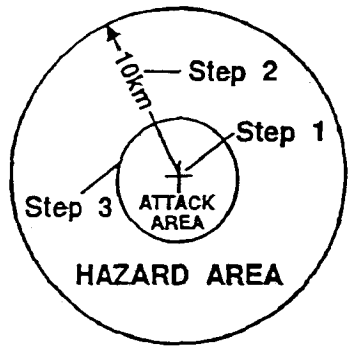
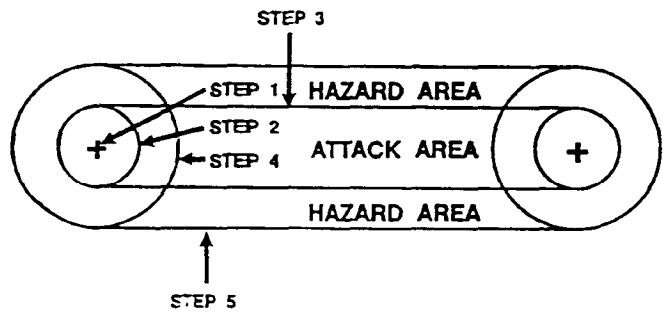

Figure 3-18. Plot for downwind hazard, Type B, Case d.

Example (Type B, Case d) (special).

A 005  
 D 220730Z  
 F LB212295 to LB242295 Actual  
 H Nerve, Persistent, Spray  
 PA 010 km  
 PB AA 2-4 days, HA 1-2 days  
 Y 0105 deg, 008 kmph  
 ZA 219452  
 ZB Type B, Case d (special)  
 NBC 3 Chemical



NOTE: Figure above is not to scale.

Figure 3-19 Plot for downwind hazard, Type B, Case d (special).

### Recalculation Procedures for Wind Speed Changes

**Step 1.** If the increase in wind speed is 10 kmph, then the NBC 3 Chemical Report must be changed (line Yankee) to alert units to the earlier arrival time-

**Step 2.** If there is a change from > 10 kmph to < 10 kmph or vice-versa, the new attack area must be determined and the new prediction must be replotted.

### For a Stability Category Change (Type A, Case b).

**Step 1.** Determine the distance the cloud will have reached (current windspeed X time after attack), and mark this on the downwind direction line.

**Step 2.** Using this point as the center, draw a circle with a radius of one half the width of fan (measured from the center pint). This is the new center of attack area.

**Step 3.** Determine the maximum downwind distance with the new stability category and subtract from it the distance the cloud has already traveled. Plot the remaining distance along the downwind direction line to establish the maximum downwind distance line. If the maximum downwind distance point lies within the radius of new attack area, extend it to the edge of the circle.

**Step 4.** Move twice the radius up the downwind direction line, establish a point, and draw the tangent lines from this point, just touching the edge of the attack area circle and extending to intersect with the maximum downwind distance line.

**Step 5.** Prepare a new NBC 3 Chemical Report.

### For a Change in Direction of 30 Degrees (or more) Type A Attacks

**Step 1.** Plot a point on the downwind direction line that the cloud center would have reached (multiply current windspeed times the time) when the new wind direction occurred.

**Step 2.** Around this point, draw a circle with a radius of half the width of the fan (measured from center pint). This is the new attack area.

**Step 3.** From the center point, plot a line representing the new downwind direction.

**Step 4.** Subtract the distance the cloud has already traveled from the maximum downwind distance as determined from Table 3-5. Plot a point representing the new maximum downwind distance and draw a line perpendicular to the downwind direction.

**Step 5.** Move twice the radius up the downwind direction line. Establish a point, and draw tangent lines from this point, just touching the edge of the attack area circle and extending to intersect with the maximum

downwind distance line.

**Step 6.** Prepare a new NBC 3 Chemical Report

### For a Change in Direction of 30 degrees (or more) Type B Attacks.

**Step 1.** Using the original point of attack, reposition the fan along the new downwind direction line.

**Step 2.** Prepare a new NBC 3 Chemical Report.

**Step 3.** Units not located within the old or new fan but located within the arc created by the shift of the wind should also be warned.

### Time of Arrival

The earliest an agent can be expected to arrive at a location is determined by dividing the distance from the attack center by 1.5 times the wind speed. For example, if you are 10 kilometers from the attack center and the wind speed is 5 kilometers per hour, the earliest the agent cloud would arrive at your location would be 1.33 hours.

$$10\text{km} \div (1.5 \times 5 \text{ kmph}) = 1.33 \text{ hr}$$

## Chemical Hazard Prediction at Sea

Chemical hazard prediction procedures at sea provides information on the location extent, and duration of the hazard area at sea as well as along coastal regions. It provides information necessary for commanders to warn units at sea and on the adjacent shore areas.

Definitions used in Naval Chemical hazard predictions are:

- **Attack Area.** The attack area is the area immediately affected by the delivered chemical agents at sea or on the shore line. If the location of the attack area is unknown, it is assumed to be located up-wind, at a distance equivalent to the units maximum range of reconnaissance. The size of the attack area is assumed to be contained within a 0.5 nautical mile (NM) radius circle.

- **Hazard Area.** The hazard area is the area in which unprotected personnel may be impaired in completing their mission by vapor spreading downwind from the attack area. The downwind hazard distance depends strongly on the defined hazard.

- **Defined Levels of Hazard.** In this procedure (three) different levels of hazard maybe taken into account.

- LCt50,
- ICt5, and
- miosis

The following dosage limits (mg x min/m3) are used.

Agent LCt50 ICt50 ICt5 Miosis

GB 70 35 5 3

GD 70 35 5 3

Only these agents are considered as a threat for naval forces. These chemical agents are the most damaging for ships at sea. Naval land forces follow the procedures and defensive actions outlined previously in this chapter.

When preparing a NBC 3 Chemical Report, indicate which hazard level the predicted hazard area is based upon in letter item ZB.

### General Procedures

The horizontal extent of the downwind hazard area depends on—

- The type of chemical agent,
- The means of delivery (agent concentration in the attack area),
- the meteorological conditions, and
- the defined hazard (hazard level).

The vertical extent hazard extends at least up to 150 meters above the sea surface. Warn air crews flying low level.

Chemical attacks may basically be divided into-

- Air contaminating attacks (Type A attacks), (nonpersistent agents), and
- ground contaminating attacks (Type B attacks), (persistent agents).

Air contaminating Attacks (Type A attacks)—For prediction purposes, two types agents are recognized—

- Type A.1—Sarin (GB) and all other known nonpersistent agents, and
- Type A.2—Soman (GD) as an aerosol.

If the agent can not be identified, assume Type A. 1.

Ground contaminating Attacks (Type B attacks), (persistent agents):

After an attack with ground contaminating agents at sea, the hazard area will always be assumed to extend 10 nautical miles (NM) downwind, when the representative wind speed is more than 5 knots. At wind speeds of 5 knots or less, the hazard area is assumed to be contained within a circle with a radius of 10 nautical miles.

The following delivery means are recognized-

- Artillery (ART),
- multiple rocket launcher (MRL),
- missiles/rockets (RKT),
- bombs, massive (BOM),
- aircraft spray (AIRSPR).

In cases where the means of delivery is unknown, missiles are assumed.

### Meteorological Data.

The meteorological data required for the downwind hazard area prediction procedure is provided in the form of a Naval Chemical Downwind Message (NAV CDM),

which is transmitted 4 times daily by appropriate agencies and is valid for a 6 hour period, which is subdivided into three 2 hour periods.

Valuable MET information can be provided by the attacked unit itself. Therefore units at sea reporting a chemical attack should always attempt to include actual weather information under letter items, Y and ZA in NAV NBC 1 CHEMICAL or NAV NBC 2 CHEMICAL Reports. ZA may be encoded or in clear text.

### Elevated Inversion Layers.

Certain meteorological conditions, known as elevated inversion layers, in the atmosphere act like a lid and trap the agents underneath.

This may lead to situations in which the chemical agent concentration aloft is very much higher than at the surface. The stability conditions determined at the surface are neutral or even unstable in these cases, resulting in much shorter hazard distances.

Such situations are indicated in the NAV CDM by the letter "S" appearing in the coded significant weather phenomena. In this case, air crews must-be given an appropriate warning.

### Prediction Procedures.

For sea areas, the prediction of chemical downwind hazard areas follows either the simplified, or detailed procedure.

The simplified procedure is intended for use on ships, whereas the detailed procedure is designed for use in NBC Centers at Naval Headquarters, where trained NBC personnel and suited facilities are available.

## Naval Chemical Downwind Message (NAV CDM)

The NAV CDM is computed essential in the same manner as the land CDM. In most cases, the CDM information is obtained through land based NBC Centers.

In the event, however, that land CDM information is not available or differs significantly from the weather conditions at sea, Figure 3-20 is used to determine the stability category. The numbers one through seven depicted on the graph refer to the seven stability categories used in the land CDM.

Once the stability category is determined, enter Table 3-7 or 3-8 (page 3-24), depending on which agent was used, to determine the downwind hazard distance.



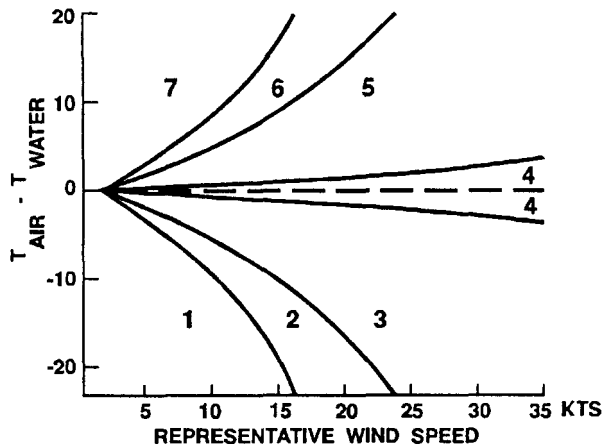

Figure 3-20. Determination of Air Stability Category (SEA)

## Naval Chemical Downwind Hazard Prediction Simplified Procedure

If a valid NAV CDM is not available, Figure 3-20 may be used to determine the air stability category, which is the basis for the determination of the maximum downwind hazard distance.

This distance is determined from Tables 3-7 and 3-8 (page 3-24). When using the simplified procedure, use the downwind hazard distances related to miosis.

The representative downwind direction and downwind speed must be determined onboard the affected ship.

### Determination of the Hazard Area

The hazard area is determined as follows:

**Step 1.** The center of the attack area (NBC 1 Chemical or NBC 2 Chemical letter item F) is plotted on the chart. A circle, the radius of which is 0.5 NM is drawn around the center. This circle represents the attack area (Figure 3-21).

**Step 2.** A template for a simplified chemical hazard area prediction is placed on the chart in such a way that the

center point of the template circle coincides with the center of the attack area and so that the value on the protractor, corresponding to the downwind direction given in the NAV CDM is oriented towards the north on the chart. A sample template is at Figure 3-22.

**Step 3.** This position of the template is marked on the chart by using holes punched in the template along the downwind axis. The template is then moved back along the downwind axis until the radial lines become tangents to the circle (30 degrees standard). Use the holes punched out along the radial lines to mark the position and connect to circle, forming tangents.

**Step 4.** The maximum downwind hazard distance is marked on the downwind axis. Through this point a line is drawn perpendicular to the downwind axis, to intersect the tangents (Figure 3-23).

When, in the NAV CDM, light or variable winds are reported (wind speeds of 5 kts or less or variable wind direction (999), the hazard area is represented by a circle concentric to the attack area, with a radius equal to 15 NM.

## Naval Detailed Chemical Downwind Hazard Prediction

The detailed procedure for prediction of chemical downwind hazard areas is designed for use at naval headquarters, and leads to a more accurate prediction than does the simplified procedure. The detailed procedure is based upon the information compiled in the "Chemical Prediction Data Sheet" (CPDS) and NAV NBC 1 or NAV NBC 2 Chemical Report. The CPDS < Figure 3-3 must be filled in immediately on receipt of a new and updated CDM, and check on the receipt of a NAV NBC 1 or NAV NBC 2 Chemical containing meteorological information in letter items Y and ZA.

The delineation of the hazard area resulting from an attack with chemical agent requires information on the chemical agent and means of delivery.

Location of the attack area as reported in NAV NBC 1 or NAV NBC 2 Chemical Report

Representative downwind direction of the agent cloud (taken from CPDS).

Maximum downwind hazard distance(s) related to the appropriate hazard level(s) (LCt50) and/or ICt and/or

Table 3-7. Downwind Hazard Distance (Nautical Miles) "Sea"

Agent: SARIN Weapon: ARTILLERY Eff. Payload: 650 kg									Agent: SOMAN Weapon: ROCKET/MISSILE Eff. Payload: 250 kg								
STABILITY	1	2	3	4	5	6	7	DOSE	STABILITY	1	2	3	4	5	6	7	DOSE
Wind (KTS) 5 - 9	<1 4 4	<1 4 6	<1 6 8	<1 8 10	<1 8 12	2 10 12	2 8 12	LCt50 ICt5 MOISIS	Wind (KTS) 5 - 9	<1 2 2	<1 2 4	<1 2 4	<1 4 4	<1 4 6	<1 4 6	<1 4 6	LCt50 ICt5 MOISIS
10 - 14	<1 2 4	<1 4 6	<1 6 8	<1 6 10	<1 8 12	2 10 14		LCt50 ICt5 MOISIS	10 - 14	<1 2 2	<1 2 2	<1 2 4	<1 2 4	<1 4 6	<1 4 8		LCt50 ICt5 MOISIS
15 - 19		<1 2 4	<1 4 6	<1 6 8	<1 6 10			LCt50 ICt5 MOISIS	15 - 19		<1 2 2	<1 2 2	<1 2 4	<1 2 4			LCt50 ICt5 MOISIS
20 - 24			<1 4 4	<1 4 6	<1 6 8			LCt50 ICt5 MOISIS	20 - 24			<1 2 2	<1 2 2	<1 2 4			LCt50 ICt5 MOISIS
25 - 29			<1 2 4	<1 4 6	<1 4 8			LCt50 ICt5 MOISIS	25 - 29			<1 2 2	<1 2 2	<1 2 4			LCt50 ICt5 MOISIS
30 - 34			<1 2 4	<1 4 4	<1 4 6			LCt50 ICt5 MOISIS	30 - 34			<1 2 2	<1 2 2	<1 2 2			LCt50 ICt5 MOISIS

NOTES: (1) For "artillery 650 kg": One minute of fire at maximum rate from a regimental artillery group consisting of two battalions of 122 howitzers and one battalion of 152 howitzers (18 guns/battalion).

(2) For "rocket/missile 250 kg": One FROG or SCUD missile.

Table 3-8. Downwind Hazard Distance (Nautical Miles) "Sea"

Agent: SARIN Weapon: BOMBS Eff. Payload: 600 kg									Agent: SARIN Weapon: MULTIPLE ROCKET LAUNCHER Eff. Payload: 3500 kg								
STABILITY	1	2	3	4	5	6	7	DOSE	STABILITY	1	2	3	4	5	6	7	DOSE
Wind (KTS) 5 - 9	<1 4 4	<1 4 6	<1 6 8	<1 6 10	<1 8 12	2 8 12	2 8 10	LCt50 ICt5 MIOSIS	Wind (KTS) 5 - 9	2 12 16	2 16 22	2 20 30	4 26 36	4 28 38	4 26 34	4 20 26	LCt50 ICt5 MIOSIS
10 - 14	<1 2 4	<1 4 6	<1 4 8	<1 6 10	<1 8 12	2 10 12		LCt50 ICt5 MIOSIS	10 - 14	2 12 16	2 14 20	2 20 28	2 26 38	4 30 44	4 32 42		LCt50 ICt5 MIOSIS
15 - 19		<1 2 4	<1 4 6	<1 4 8	<1 6 10			LCt50 ICt5 MIOSIS	15 - 19		2 10 16	2 16 22	2 20 30	2 26 38			LCt50 ICt5 MIOSIS
20 - 24			<1 2 4	<1 4 6	<1 6 8			LCt50 ICt5 MIOSIS	20 - 24			2 12 18	2 18 26	2 22 34			LCt50 ICt5 MIOSIS
25 - 29			<1 2 4	<1 4 6	<1 4 6			LCt50 ICt5 MIOSIS	25 - 29			2 10 16	2 14 22	2 20 30			LCt50 ICt5 MIOSIS
30 - 34			<1 2 4	<1 2 4	<1 4 6			LCt50 ICt5 MIOSIS	30 - 34			2 10 14	2 12 20	2 18 28			LCt50 ICt5 MIOSIS

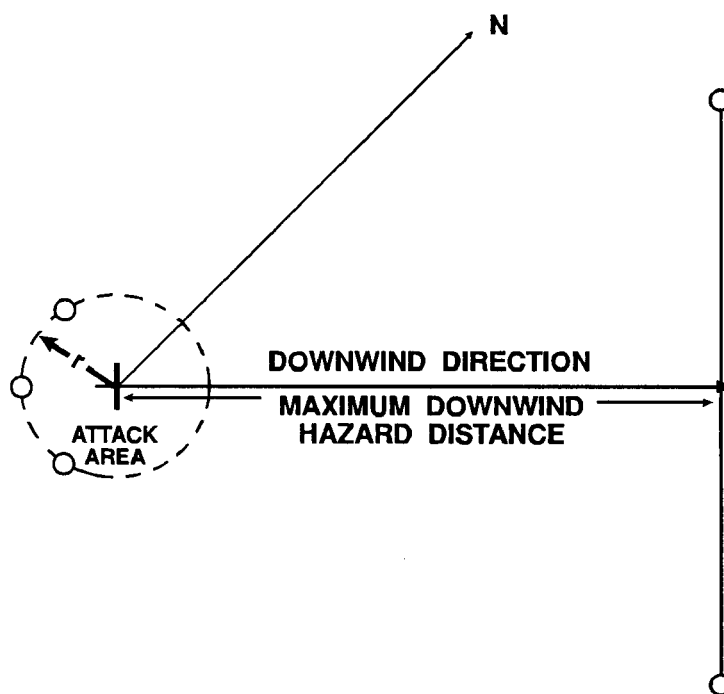
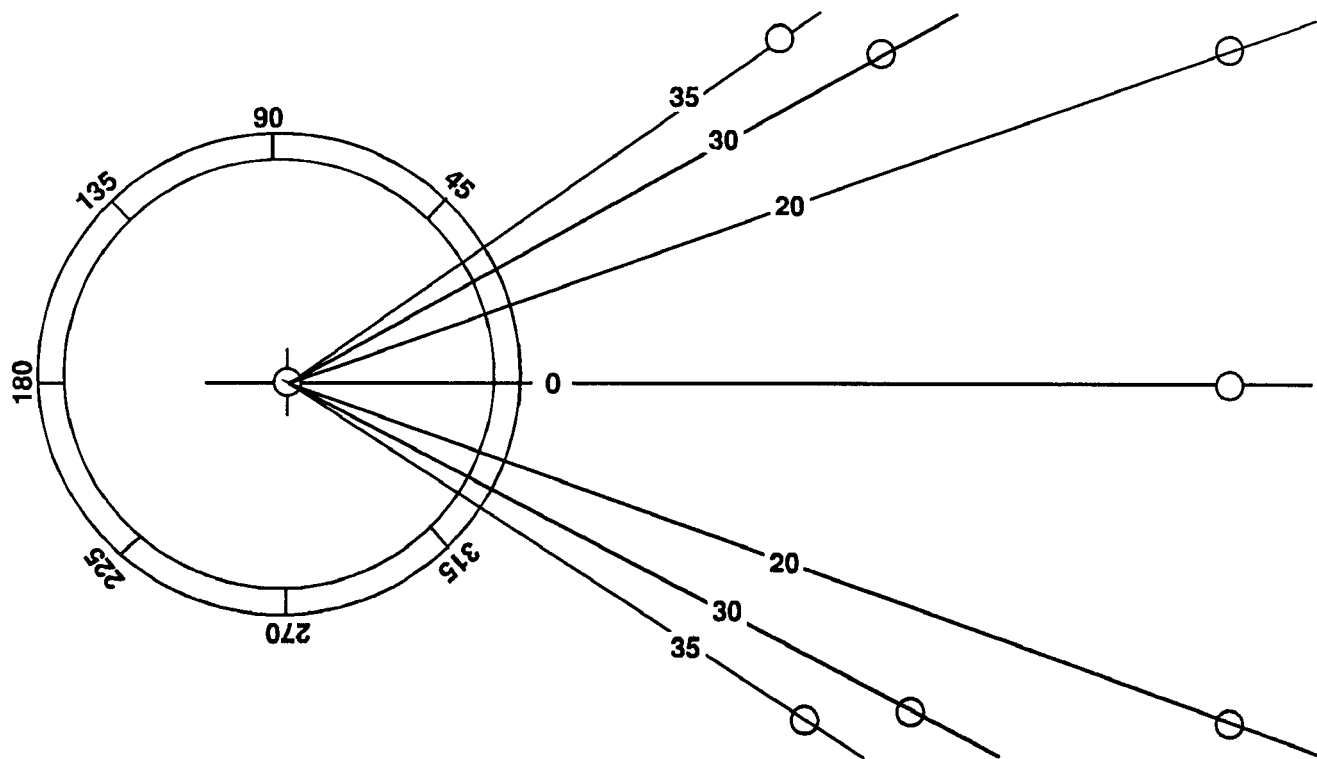

Figure 3-21, Step 1, Chemical Downwind Hazard Area.



Note—0 represents areas to puncture holes as described in step 3.

Figure 3-22. Chemical Ship's Template.

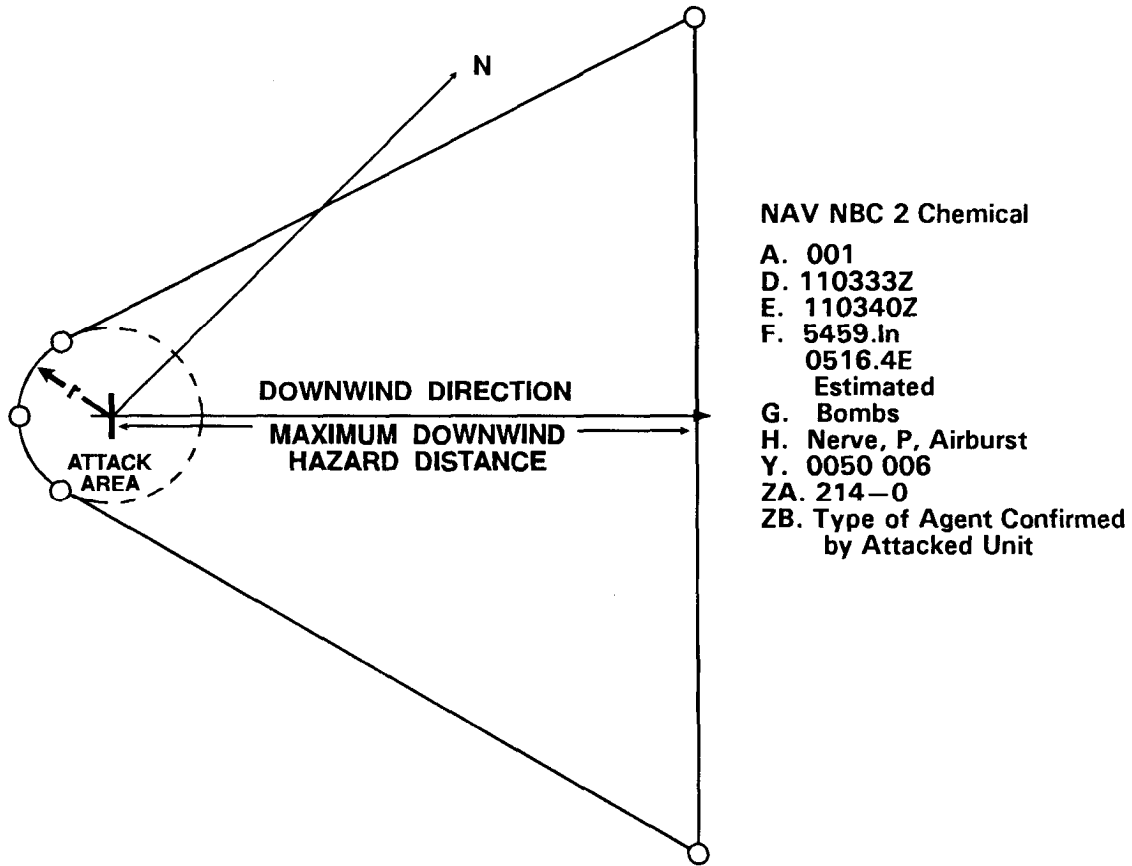

Figure 3-23. Completed Simplified Chemical Downwind Hazard Area with NAV NBC 2 Chemical Report.

miosis) (taken from CPDS).  
 Half-sector angle of the hazard area:  
 - 35 degrees for wind speeds higher than 5 knots, but less than 10 knots  
 - 20 degrees for wind speeds of 10 knots and more.  
 For wind speeds equal to 5 knots or less, the hazard area will be circular with radius equal to the downwind hazard distance for 5 knots wind speed. However, the radius should not exceed 15 nautical miles.

ZCZC 054  
 fxd182 edzl  
 110525Z  
 NAV CDM  
 110500 11 Aug  
 06U0GMT  
 JQ 12  
 W: 999005  
 11470-  
 X: 040010  
 31566-  
 Y: 070012  
 41666-

**Determination of the Downwind Hazard Area.**

**Step 1.** To plot the chemical downwind hazard area on a sea chart or on general operations plot, the above information is used in the following way (see Figure 3-22).

Chemical Prediction Data Sheet			
Agent: SARIN			
Hazard Level: ICt5			
Delivery Means: Artillery			
1	NBC-Center: AMZ BSN		
2	Area of validity: JQ 12		
3	Originator of NAV CDM: F1Kdo/GEOPHYS B1SL N		
4	Date: 11 Aug 19XX	Period	
5	Time of Validity: 0600Z - 1200Z	W	X
6	Downwind Direction (Degrees)	999	040
7	Representative Downwind Speed 10 m (KTS)	5	10
8	1.5 Times the Wind Speed (KTS)	7.5	15
9	.5 Times the Wind Speed (KTS)	2.5	5
10	Stability Category	1	3
11	Temperature (Centigrade)	14	15
12	Humidity	7	6
13	Significant Weather Phenomena	-	Rain
14	Cloud Coverage	-	-

Figure 3-24. Chemical prediction date sheet sample.

**Step 2.** Plot the location of the attack area. If the exact location (center of the attack) is known, draw a circle around this point with a radius of 0.5 nautical miles. If only a dissemination area is reported determine the center point of this area and draw a circle around this point, using a radius of 0.5 nautical miles. If the size of the attack area is known to be larger, the radius must be adjusted accordingly.

**Step 3.** From the center of the attack area circle draw a line, representing the downwind direction.

**Step 4.** Draw two lines which, being tangents to the circle, form an angle equal to the half sector angle on either side of the representative downwind direction (downwind axis).

**Step 5.** Label the point on the downwind direction line (downwind axis, thus marking the extent of the downwind hazard distance(s) for the relevant level(s) of hazard LCt50 and/or ICt5 and/or miosis) and draw a line through this (these) point(s), perpendicular to the downwind axis and intersecting the two tangents. The downwind hazard area(s) is (are) contained within (these) line(s), the tangents and the upwind arc of the attack area circle.

When low wind speeds or variable wind directions are reported in the NAV CDM, (wind speed 5 knots or less or variable wind direction (999)), draw a circle

A. 006  
 D. 110558Z  
 F. 5447.3N 0643.8E  
    Actual  
 G. MRL  
 H. SARIN Surface Burst  
 PA. 015  
 Y. 0999 005  
 ZA. 1144-0  
 ZB. DHD MIOSIS 16 NM  
      DHD ICt5 12 NM  
      DHD ICt50 2 NM

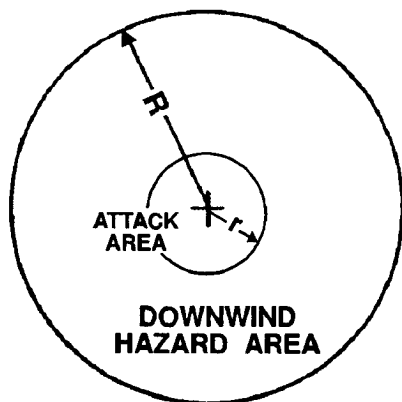

Figure 3-25. Downwind Hazard Area, Type "A" Attack, Wind Speed 5 kts or Less or Variable.

concentric to the attack area circle, using the relevant downwind hazard distance as the radius. However, the radius should not exceed 15 nautical miles (see Figure 3-25).

When wind speeds are 10 knots or more, the chemical plot and subsequent NBC 3 Chemical Report would look like that shown in Figure 3-26.

If the meteorological conditions change within the period of duration of the hazard, the predicted hazard area must be adjusted only if—The stability category changes from one category to another, and/or the wind speed changes by more than 5 knots or from 5 knots or less to more than 5 knots and vice versa, or the wind direction changes by more than 20 degrees.

The hazard area is then determined as follows:

Calculate the downwind distance which the agent cloud may have travelled at the time the change in the meteorological conditions occurred, by using the representative downwind wind speed. Consider this point to be the center point of a "new" attack area, and draw a circle around it with a radius equal to half the width of the hazard area at that point. From there on, repeat the steps described earlier for determination of the downwind hazard area. The distance which the agent cloud may already have travelled must be subtracted from the maximum downwind hazard distance under the new weather conditions (Figure 3-27).

When a cloud from a chemical agent crosses the coastline from sea to land or vice versa, consider the point where the downwind direction line (downwind direction line or downwind axis) intersects the coastline to be the center point of a "new" attack area. Follow the procedure described above, using the appropriate tables for sea and land to determine the downwind hazard distances. When frequent changes occur, use land procedures when working manually.

In the case of air contaminating attacks, the beginning and the end of the hazard at a certain location may be determined from—the representative downwind speed, the distance of the location from the edge of the attack area, and the beginning and the end of the attack.

The following two formulas are used:

$$t_B = (d_\mu \times 60) / (1.5 \times V_Z) \text{ or}$$

$$t_B = (d_\mu \times 40) / V_Z \text{ and}$$

$$t_E = (D_\mu \times 60) / (0.5 \times V_Z) \text{ or}$$

$$t_E = (d_\mu \times 120) / V_Z = 3 \times t_B$$

$t_B$  = time in minutes from the beginning of the attack to the beginning of the hazard.

$d_\mu$  = distance between the location and the downwind edge of the dissemination area (in NM).

$V_Z$  = wind speed in kts. If necessary, the wind speed must be determined as the mean wind speed over several periods of validity of the NAV CDM.

A. 002  
 D. 110835Z  
 F. 5433.6N  
 0655.4E  
 G. ART  
 H. SARIN, Ground  
 Burst  
 PA. 5433.3N  
 0654.7E  
 5433.8N  
 0655.9E  
 5441.8N  
 0655.9E  
 5435.1N  
 0709.4E  
 5433.2N  
 0655.7E  
 Y. 0040 010  
 ZA. 315-61  
 ZB. Half Sect.  
 Angle  
 20 Deg.  
 DHD MIOSIS 008 NM  
 DHD ICt5 006 NM  
 DHD ICt50 001 NM

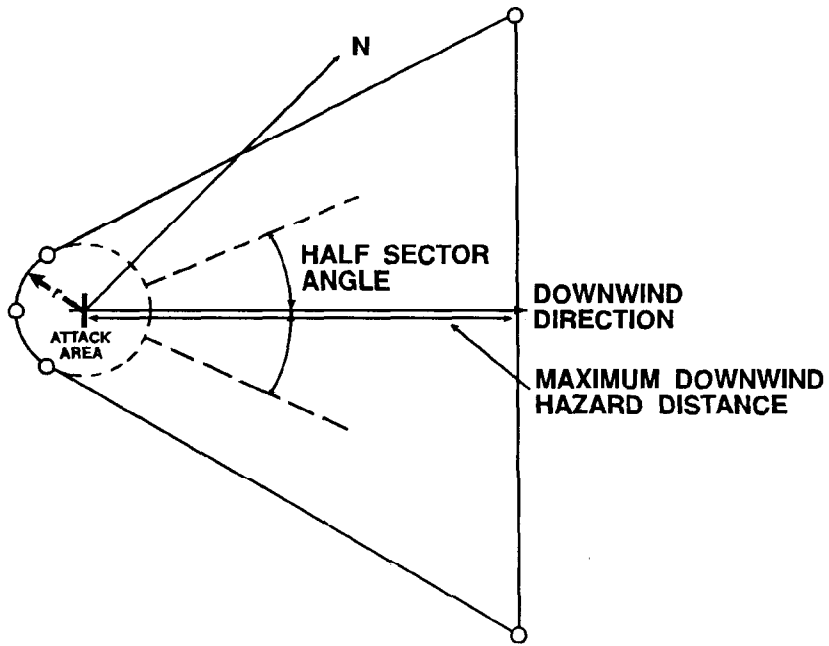

Figure 3-26. Downwind Hazard Area, Type "A" Attack, Wind Speed 10 kts or more.

$t_E$  = time in minutes from the end of the attack to the end of the hazard.

Example:

Given- $\alpha_p$  = 5 NM,  $V_z$  = 10 kts.

Using the formulas,  $t_B$  and  $t_E$  are calculated as follows—

$t_B = (5 \text{ NM} \times 40) / 10 \text{ kts} = 20 \text{ minutes}$ , and

$t_E = (5 \text{ NM} \times 120) / 10 \text{ kts} = 60 \text{ minutes}$

So, the beginning of the hazard is expected at this location 20 minutes after the beginning of the attack and is expected to end 60 minutes after the end of the attack.

The expected maximum duration of the hazard may be obtained by using the maximum downwind hazard distance as  $d^{\wedge}$ , and calculating  $t_E$  from the formulas.

The NBC agency (NBC Collection Center/NBC Sub-Collection Center) must continuously check the NAV NBC 3 Chemical Report issued, in order to ensure that any new information (meteorological or NBC) is considered.

If necessary, a corrected NAV NBC 3 Chemical Report must be transmitted.

### Avoidance Procedures

Once chemical agent hazard areas are plotted, units may elect to by-pass suspected contamination or operate within these areas. If the unit elects or is required to operate within a contaminated environment, refer to FM 3-4 for performance degradation factors. Appendix A to this field manual provides a checklist for CB operations

for platoon through Brigade Task Forces. This checklist may serve as a guide for unit operations in a contaminated environment.

### Vehicle Operations

If agents have been used, soil particles become contaminated. When a track vehicle moves across the surface and its movement causes these soil particles to be suspended in the air, liquid droplets of chemical agent are also suspended in the air. The suspension of the chemical agent, therefore, becomes an increased threat to follow on vehicles.

Table 3-9. Calculated Maximum Distance of Agent Travel

Agent Travel <sup>1</sup> (meters) by Vehicle Type				
Vehicle Speed (mph)	M1 (A1)	M60	M2/M3	M113
6	1	1	1	1
12	4	4	3	3
18	7	7	6	6
24	13	12	10	11
30	19	18	16	16
35	26	25	21	22
40	34	32	27	28
45	43	40	34	35
50	52	49	42	43

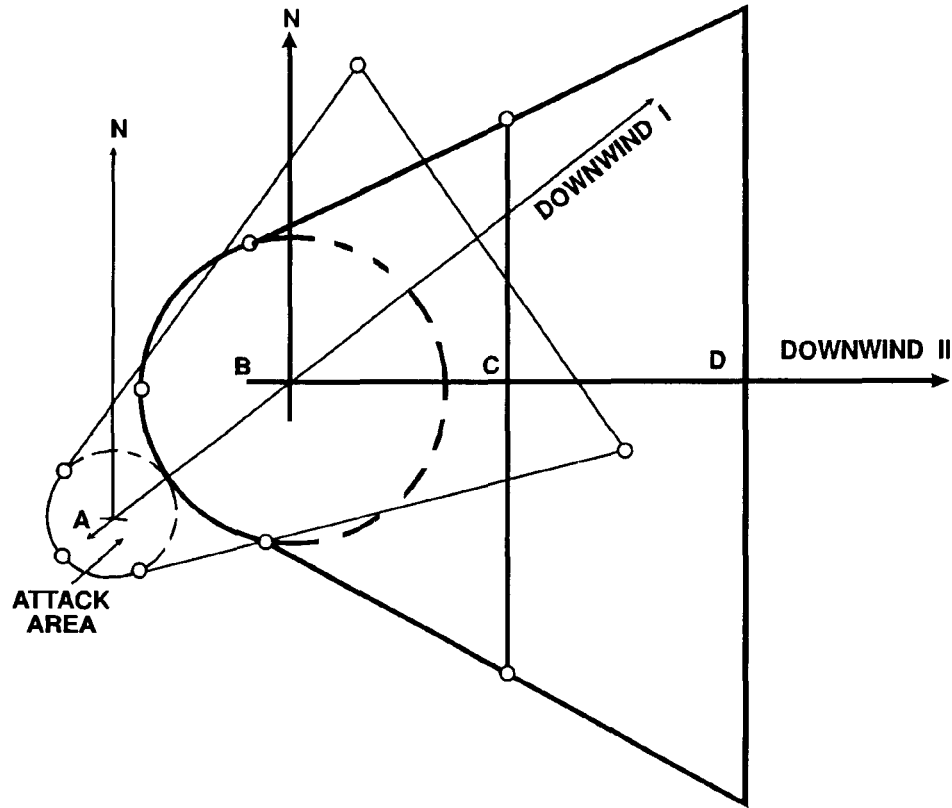

Figure 3-27. Recalculation of Downwind Hazard Area, Type "A" Attack, After Change in Downwind Direction at Point B.

One of the basic tenants of crossing contaminated terrain is to keep the contamination level as low as possible. Based on recent studies the distance that chemical agents may travel when suspended in the air by vehicle movement is depicted in Table 3-9.

The data presented in Table 3-9 represents the distance in meters that chemical agent contaminated soil particles may travel, regardless of wind effects. When track vehicles move across contaminated terrain, it is possible that minute droplets of chemical agent, as small as 25 micrometers (urn), may become suspended in air and carried by the natural or vehicle induced air currents. These droplets may rise as high as 10 meters above the surface and extend downwind as far as 3 km. To reduce agent contamination trail vehicles should remain "button up" even if no vapor contamination is detected while transverse terrain.

Units in the traveling formation may also encounter cross-contamination to some degree if a lateral interval sufficient to avoid dust from the side of the track vehicle is not maintained. In the absence of cross winds a 50 meter spacing laterally is sufficient to avoid cross-contamination.

### Helicopter Operations

Helicopters flying over contaminated terrain may also suspend chemical agents in the air increasing the risk to aircraft following close or directly behind the lead aircraft. Recent test results indicate that to avoid cross-contamination from the lead aircraft pilots should double the normal trailing distance between aircraft. Further, according to these studies aircraft flying at an airspeed of 50 knots or more and at an altitude of 84 feet or higher (or an H/D of 2.0), above contaminated terrain may not receive an incapacitating vapor dosage of chemical agent inside the aircraft as long as all doors, windows and vents are closed.

In the event that this altitude or airspeed cannot be achieved or maintained monitor the interior of the aircraft with the M8A1 Chemical Agent Alarm or the Chemical Agent Monitor (CAM).

If the aircraft becomes contaminated, flying with the doors and windows open for approximately 15-20 minutes at approximately 90 knots, will reduce the contamination level by 95%. This may reduce the contamination level to such an extent that unmasking procedures may be initiated using the M256A1 Chemical Agent Detector Kit.

## Chapter 4

# Biological Agents

The avoidance of biological agents requires an understanding of what biological agents are, how they may be used, and what happens to them once they are released. Units can then anticipate when and where biological agents will be used. They can estimate where the hazard is located so avoidance procedures can be initiated.

Biological agents are divided into two broad categories — pathogens and toxins.

### Pathogens

Pathogens are infectious agents that cause disease in man, animals, or plants. Agents that constitute antipersonnel biological warfare (BW) threats include bacteria, viruses, and rickettsias (see Appendix B). These are commonly referred to as germs. While the vast majority of microorganisms are harmless or even helpful, there are about 100 naturally occurring pathogens that could be used as biological warfare (BW) agents. Pathogens cause disease (infection) by entering the body through the lungs, digestive tract, through the skin and mucous membranes of body openings.

Once they enter the body, pathogens multiply, overcoming the body's natural defenses, and produce disease. All bacteria do not require living cells for growth. Symptoms most commonly associated with pathogen infection include upper respiratory flu or cold like symptoms, vomiting, diarrhea, pneumonia or skin lesions (spots or rashes). Some pathogens, cause nervous systems damage (headache, paralysis, convulsions, or coma).

### Bacteria

Bacteria are living microorganisms. Unlike viruses and rickettsias, they are capable of reproduction outside living cells. If they enter the body and if the victim is not properly treated, the microorganism will multiply and incapacitate the host. Bacteria can be found in almost any environment. Those few that are potential BW agents have the ability to rapidly cause illness after entering the body through the lungs or digestive tract. A typical bacterial cell is 1-2 microns in diameter and 2-10 microns in length (1,000,000 microns = 1 meter).

### Viruses

Viruses constitute a large group of infectious organisms. Unlike bacteria, they must be inside a cell in order to multiply. Viruses multiply by taking over the cell, causing it to produce viruses instead of normal cell components. After producing hundreds or even

thousands of virus particles, the cell is often destroyed as these particles are released. Viruses are much smaller than bacteria, ranging from 0.02 - 0.2 microns in size. Their small size means that a relatively small amount of agent can infect a large number of personnel across a wide area.

### Rickettsiae

Rickettsiae are bacteria that are unable to multiply unless they are within a living cell. Most are spread from one person to another by means of an insect or tick that serves as a vector. The rickettsia will be picked up by the vector from one infected person or animal, which then transmits the rickettsia when it bites its next victim. Rickettsiae are smaller than most bacteria, but larger than viruses.

### Toxins

Toxins are poisonous substances produced as by-products of microorganisms (the pathogens), plants, and animals. Some toxins can be chemically synthesized, and some can be artificially produced with genetic engineering techniques. Toxins exert their lethal or incapacitating effects by interfering with certain cell and tissue functions. Basically, there are toxins that disrupt nerve impulses (neurotoxins) and toxins that destroy cells by disrupting cell respiration and metabolism (cytotoxins). There is a vast range of signs and symptoms with both toxin types. These signs and symptoms can be confused with both chemical and pathogen poisoning.

The neurotoxins tend to be quick acting and produce nerve agent-like symptoms in seconds to hours. Symptoms of neurotoxin poisoning range from mental confusion, loss of balance, and vision problems to a limp paralysis or convulsive-type seizures leading to coma and death.

An example of a neurotoxin is palytoxin, produced by a bacterium in palythoa soft corals. This is a fast acting toxin causing muscle paralysis then death within 5 minutes.

Cytotoxins tend to be slower acting and produce choking, blistering, or even radiation-like symptoms in a period of hours to days. Symptoms range from skin lesions such as blisters, to vomiting, diarrhea, coughing, and choking (the latter three signs may be accompanied by bloody discharges) to marked weakness, coma, and death.

An example of a cytotoxin is trichothecenes (T-2



toxin) which is a group of about 40 delayed acting, fungal toxins (mycotoxins). These are produced from molds of infected grain and were reportedly used in Southeast Asia and Afghanistan in the 1970's and 1980's. T-2 toxin is often referred to as "yellow rain."

## **Characteristics of BW Agents Delayed Effects**

Both pathogens and some toxins - especially cytotoxins - can cause delayed effects. These effects may take hours to days before the onset of disease.

The effects of pathogens are delayed due to the required incubation period. This incubation period is the growth process of pathogens inside the body prior to disease production and differs among agents.

Toxins, unlike pathogens, are not living organisms. The delayed effects are not caused by an incubation period. The delay is caused by the time required to kill or inactivate cells. Repeated exposures to small amounts (less than incapacitating or lethal effective doses) can add up to an incapacitating or lethal effective dose.

### **Large Area Coverage**

Biological agents can be disseminated over large areas. They can sail with the wind and travel extensive distances downwind. Pathogens can infect the target with as little as 1 to 20 microorganisms. Billions of pathogenic cells can be packed in 1 gram of agent. The light weight and small size allow these pathogens to spread easily to all areas that are not airtight. Similarly, toxins are very potent and are more toxic than nerve agents. They require very low doses to exert their effects. Toxins, like pathogens can cover large areas when disseminated.

### **Control**

Somewhat more control can be achieved in employing toxins as compared to pathogens and they can cover larger areas than those covered by chemical aerosols. Compared to the pathogens, they are extremely toxic and lightweight, particularly if employed as an aerosol. However, being chemical by-products rather than living organisms, toxins are not infectious, contagious, nor capable of self-reproduction. Thus, area coverage and the results of the attack are much more predictable and reliable.

Pathogens, however, are difficult to control: especially if they are artificially disseminated. Because some pathogens cause contagious diseases, the victim himself becomes the source of agent. Both sick and dead soldiers, and their wastes, can become a hazard to

those around them. The extent of this hazard will vary from agent to agent, but it is an important part of controlling and avoiding further casualties. Also, the coverage patterns of pathogen agent clouds are very sensitive to wind direction and speed. The enemy may decide to use pathogens in an attack located close to their own positions. In this case the enemy will be forced to use a pathogen for which their troops have immunization, or the enemy must be willing to accept some casualties.

In general, healthy skin provides an adequate barrier against most agents of biological origin. Skin (usually in a tropical environment) that has rashes, scratches, fungal infections, etc . . . is more susceptible to skin penetrants.

### **Skin Penetration**

Some toxins, due to their small molecular weight, size, and solubility, may also penetrate the skin. MOPP gear protects the skin from the effects of such toxins and therefore must be used. For maximum protection and the lowest risk of incurring casualties, soldiers should wear the protective gear for 4 hours after the unit has been attacked or the agent cloud is predicted/known to have passed through the unit area. During this time every effort is made to identify the exact agent including its characteristics.

## **Weather Effects on Biological Agents**

### **Sunlight**

Most biological pathogens and some toxins are affected by ultraviolet rays in sunlight. Most attacks will likely occur at night, during extended twilight, or during overcast conditions. To overcome this problem, encapsulation (a natural or man made protective covering around the pathogen), or possibly genetic engineered pathogens, may produce agents that are resistant to direct sunlight. Thus, any agent delivered during conditions of direct sunlight, or after beginning morning nautical twilight (BMNT), should be considered as a sunlight resistant agent.

### **Humidity**

The relative humidity that is the most favorable for the employment of a biological aerosol attack depends upon whether the agent is disseminated as a wet or dry aerosol. For a wet aerosol, a high relative humidity slows the evaporation of the tiny droplets of agent. This lowers the rate of decay of the wet agent because drying may result in the death of pathogens. On the other hand, a low relative humidity favors the employment of dry agents. The extra moisture present in the air when

humidity is high may increase the decay rate of pathogens in a dry aerosol. High humidity may also promote a clumping of particles causing them to fall out of the air more rapidly.

**Wind**

High wind speeds increase the area covered by biological agents, but lower the casualty percentages within an area due to dilution of the agent. Most BW attacks will occur under conditions of moderate windspeed, the most effective windspeeds for target coverage being 12-30 kmph. As the agent cloud travels downwind, it gradually loses its effectiveness due to dilution caused by agent fallout, dispersal, and death of the pathogen agent or neutralization of the toxin. However, because most biological agents are lighter and more potent (weight to effect basis) than chemical agents, the downwind hazard areas of biological weapons will be much larger than those of chemical weapons. If delivered directly on target, as with a bomblet attack, the wind direction and speed will have a more limited effect on coverage, however, downwind efforts must still be considered. If dissemination occurs far upwind from the target area in a more elevated manner, downwind effects can be even more dramatic.

**Temperature Gradient**

Temperature gradients may exert some effects upon the behavior of a biological aerosol cloud. However, prediction of these effects require specific knowledge of the agent and its potential carriers. The effects of temperature gradient upon biological agents are similar to those upon chemical agents. However, because biological agents are effective in lower concentrations than chemical agents, the effects of temperature gradient are less upon a biological cloud than a chemical agent cloud. A stable atmosphere (inversion) results in the greatest effects. Under unstable (lapse) and neutral conditions, more atmospheric mixing occurs leading to a cloud of lower concentration, but still sufficient to inflict casualties. Temperature gradients for biological agents normally are listed in Pasquill Stability Classes. These classes are listed in Table 4-1. As stated previously, stable atmospheric conditions produce the best effects for biological agents. This means Stability Class E or F. The Simplified Biological Downwind Hazard Prediction (SBDWHP) procedures will be used for all temperature gradients.

**Precipitation and Temperature**

Precipitation will tend to wash biological agents out of the air more rapidly. This will slightly reduce the downwind hazard. Most pathogens are stable at normal temperatures, thus, the effects of temperature are

*Table 4-1. Pasquill Stability Classes*

Class	Definition				
A	Extremely unstable				
B	Moderately Unstable				
C	Slightly Unstable				
D	Neutral				
E	Slightly Stable				
F	Moderately Stable				
Conditions:					
Surface Wind Speed, M/Sec	Daytime			Nighttime	
	Strong	Moderate	Slight	Cloudy	Clear
< 2	A	A-B	B		
2-3	A-B	B	C	E	F
3-4	B	B-C	C	D	E
4-6	C	C-D	D	D	D
> 6	C	D	D	D	D

expected to have little or no effect on hazard predictions. With the advent of toxins, bioengineering of pathogens and encapsulation, even arctic or desert conditions are much less restrictive to the user of BW. Most toxins are more stable than pathogens and are less susceptible to the influence of temperature, relative humidity, and radiation. As a general rule cool temperatures favor the employment of wet agents and warm temperatures favor the employment of dry agents.

**Windows of Vulnerability**

Coordinate with higher headquarters, intelligence sources, and medical personnel to determine what biological agent is most likely to be employed by the enemy. Determine, based on agent the optimum weather conditions and method of dissemination for greatest effect for each agent considered.

Coordinate with the Divisional Staff Weather Officer (SWO) to determine when these optimal weather conditions are projected to exist in the Area of Operation (AO). These projected times that the optimal weather conditions exists is called "the window of vulnerability". This "window" represents the best time, based on weather, for the enemy to employ biological agents. During this "window of vulnerability" if the unit is attacked with something that appears to be a chemical agent; yet no chemical alarm or detector kit responds to the agent, submit a Suspected Biological Report and obtain samples.

**Persistence of**

**Biological Agents/hazard**

The persistency of a biological agent refers to the

duration of effectiveness of the agent and varies greatly between agents.

The persistency of a biological agent will depend on many factors. Weather, terrain, ultra violet rays, method of dissemination, and type of agent are just a few of the factors that contribute to the persistency of a biological hazard. These factors must be considered when determining or initiating unmasking procedures. The persistence of microbes can be enhanced by encapsulating them with a microscopic protective coat. In addition, some microbes will produce a very resistant form called a spore. This is an essentially dormant state which can reactivate when the proper conditions exist. Spores will survive heat, drying and even some radiation for years. The spore can remain on the ground until conditions become appropriate for the organism to survive. In a process called reaerosolization, the organism will be returned to its aerosol form by some outside means. The most probable scenario is that heavy vehicle traffic or winds will cause many of the organisms to be suspended in the air. This particle suspension will cause a hazard area of military significance. The threat of casualties due to reaerosolization of the biological agent is agent specific, but in most cases it will be below 5 percent.

Due to the sheer magnitude of potential agents, persistency data, or decay rates for biological agents is beyond the scope of this manual. Two biological agents with desirable weaponizing characteristics are Bacillus, Anthracis, and Botulinum Toxin. Decay rate or persistency rate graphs for these two agents are depicted in Appendix B, Figures B-1 through B-4.

## Use of Biological Agents Against US Forces

It is possible that pathogens and toxins will be used against U.S. forces. The employment of pathogens and toxins throughout the entire battle area cannot be discounted. Possible targets of pathogens include:

- Rear area command centers and key facilities.
- Troop assembly areas.
- Ports of embarkation or supply points, airfields and industrial centers prior to the outbreak of hostilities.

Possible targets of toxins include —

- Forward combat areas and logistical areas.
- Any area that presents a likely target for a terrorist or insurgent group.

The use of biological agents will complement the effects of other weapon systems. For example, threat forces could use pathogens with incubation periods that will cause the outbreak of disease, days or weeks after a nuclear attack. This would maximize the effects

radiation has on reducing the body's immune system. They could also use pathogens before a planned offensive maneuver. The maneuver would be timed to coincide with the incubation period of the pathogen. Troops in a weakened state due to the onset of illness will be more susceptible to fatigue, have slower reaction time, and will have their ability to make decisions hampered. This further reduces our capability to wage war. Biological agents can be used singularly or in combination with other biological or chemical agents. This causes confusion in diagnosis, delays and compounds treatment, and magnifies incapacitating or lethal effects.

U.S. forces may also be exposed to immediate and residual biological hazards as a result of direct attack or by crossing biologically contaminated areas. Contamination avoidance is essential to reduce the impact of biological hazards. Our ability to survive, fight, and win on a biologically contaminated battlefield, requires the capability for warning and detecting an attack and identifying the agent. Detecting biological agent attacks are not easy. A detection/warning device for pathogens is under development. An improved version of the M256 Detector Kit will be able to detect T2 mycotoxin. Future developmental items may include the ability to detect biological agents with the on-board mass-spectrometer for the NBC Recon System (FOX). For those agents that cannot be identified, detection is accomplished by -

Recognizing a pattern of employment to predict an attack.

- Using the IPB process with specific PIRs for advance warning.
- Recognizing the signatory symptoms, signs, and effects of biological agents.
- Sampling with air samplers may provide indication of an attack in progress.

The first two methods of detection are the only methods we have of warning troops of an attack before it occurs. The last method will alert the unit that an attack has occurred, and therefore allow the unit to take necessary protection and decon procedures to minimize the effects. Additionally, this method will help to establish a pattern of employment and, during future attacks, it will give notice (or at least high suspicion) that the enemy is employing biological agents. At this point, it should be added that when a unit is attacked, the unit can only suspect a biological attack. This suspicion is based on dissemination techniques, patterns of employment and the "window of vulnerability". Confirmation of a biological attack occurs only when a sample of the unknown agent is obtained and laboratory analysis confirms that the unknown substance is

biological in origin.

Prior to this laboratory confirmation, the unit will not know if the attack was biological or chemical from an unknown source. Mission Oriented Protective Posture (MOPP) will protect the wearer against all known chemical or biological agents. Therefore, the unit must assume MOPP Level 4 (full protection) and apply those tactics, techniques and procedures (TTP) depicted in Appendix A for chemical or biological contamination avoidance.

## Using Intelligence Sources

Intelligence can yield useful information for predicting biological attacks. Intelligence also can yield information that drives the scope and intensity of the biological defense program. Combat, technical, medical, and strategic intelligence sources must be used. Strategic intelligence gives the commander an estimate of the threat force's overall capabilities, limitations, and probable intentions for the employment of biological agents. Combat intelligence gives the commander an estimate of the threat force's battlefield readiness to employ biological agents. Technical intelligence enables evaluation of the effectiveness of enemy biological agents, possible dissemination systems and of protective equipment. Medical intelligence provides information about enemy preventive medicine, medical treatment, types of potential pathogens employed and preparations in medically related areas that could indicate a possible biological attack. See FM 8-10-8 for additional information on medical intelligence.

## Recognizing a Pattern of Employment

Using the IPB process, windows of vulnerability based on weather, enemy activity, and movement of likely dissemination systems, help characterize the patterns of employment. The time of attack, method of dissemination, type of munition used, or the stage of the operation in which the agent is employed may be similar. Similar situations or patterns will not be definite proof that a biological agent attack is imminent but early warning should be given to all units in the potential hazard area.

### Recognizing Distinguishing Symptoms, Signs, and Effects

Detecting a biological attack by this method is the least desirable way. But, due to the lack of detection devices, covert dissemination, and delayed effects of biological agents, this may be the first indication of a biological agent attack. With common diseases the number of personnel affected gradually increases.

Natural food poisoning can be caused by a bacterial toxin. But in such a case, the casualties would be limited to those personnel that consumed the infected food. This can be verified by a medical analysis. When a biological agent has been used, large numbers of soldiers are exposed at or about the same time. This causes "explosive" epidemic numbers of casualties. Criteria (signs, symptoms, and effects) for suspecting a biological attack include:

- Epidemic number of casualties occurring within hours to three days of each other (most within 24 hours of each other).
- Higher death or infection rates than normally encountered with the disease.
- Diseases or increased outbreaks of a particular disease not normally encountered in a particular region or country (for example, yellow fever in Europe).
- An aerosol dissemination technique is indicated by high numbers of respiratory signs—particularly when in nature the disease affects the body through a different portal of entry (such as pulmonary or lung-infecting anthrax versus the much more common form of skin-infecting anthrax).
- Multiple outbreaks of zoonotic disease(s) (diseases that are communicable from small animals to man).
- Personnel working in a protected environment do not contract the disease (or vice versa could indicate a covert dissemination of a biological agent).
- Casualties occurring downwind, downstream, or within a supply line pattern.
- Large numbers of sick or dead animals are observed, especially if suffering the same symptoms of the disease which is affecting the human population.
- The sudden appearance of large numbers of strange insects or ticks that have not been encountered previously in an area of operations. This information may be obtained through preventive medicine sections.

Once suspected and reported, medical staff personnel can conduct epidemiological studies and determine if there could be other causes for the outbreak and thus prevent the perpetuation of false NBC reports.

## Dissemination Techniques and Avoidance Procedures

To avoid a biological agent hazard, first; prevent the attack and second, combat (limit) the effects on personnel and supplies in the event of an attack.

The method of dissemination determines the extent and severity of contamination. However, some agent specific defenses can be administered before the agent is disseminated. These defenses may take the form of immunizations or prophylaxis, (taking medicine orally).

There are three general methods of disseminating biological agents. Each helps the agent to get into the body.

- Aerosol dissemination is used when the respiratory system is targeted.
- Vectors (such as fleas, lice, ticks, and mosquitoes) and some toxins are used to attack through the skin.
- Covert (hidden) methods are employed to attack both the respiratory and digestive systems.

**Aerosol Dissemination Procedures**

Biological agents may be disseminated by ground or airbursting munitions, aircraft spray tanks, boat or truck mounted aerosol generators. The attack most likely will occur in a covert (or hidden) manner. Tactical level are those directed at specific units or elements on the battlefield. They are likely to occur at altitudes of 1,000 feet or less (100-foot optimum). Estimation of the hazard areas resulting from dissemination at altitudes greater than 1,000 feet above ground level requires extensive meteorological analysis. Toxins can be disseminated as a liquid (such as with “yellow rain”). This makes the toxin highly visible; but the hazard will generally be limited to the immediate area of the attack.

In a tactical aerosol attack, the aerosol cloud (after

initial formation) will travel downwind at a rate determined by wind speed. The cloud will lengthen and widen as it travels downwind. The length of the agent cloud will equal about one-third of the distance traveled. Units near the release point will encounter a more concentrated agent cloud. However, units located farther downwind (even though exposed to a less concentrated agent cloud) will be exposed for a longer time, so unprotected personnel will inhale a higher total dose. Figure 4-1 shows the typical downwind movement and characteristics of a biological agent cloud. The peak danger area will be located in the area where the cloud stays in tact while at the same time is at its maximum width and length. This distance is approximately the maximum downwind hazard prediction for a chemical agent; therefore, it is vital to determine whether or not the attack is biological or chemical. The biological agent cloud can cause both immediate or delayed casualties. This is due to the fact that each individual will receive a different dose and the time until the onset of symptoms will be dependent on the amount of agent and each soldier's physiological makeup. The onset of illness will also be affected by the soldier's reaction time and any other forms of protection (i.e inoculation, masking time) that were available against the agent. Biological agent

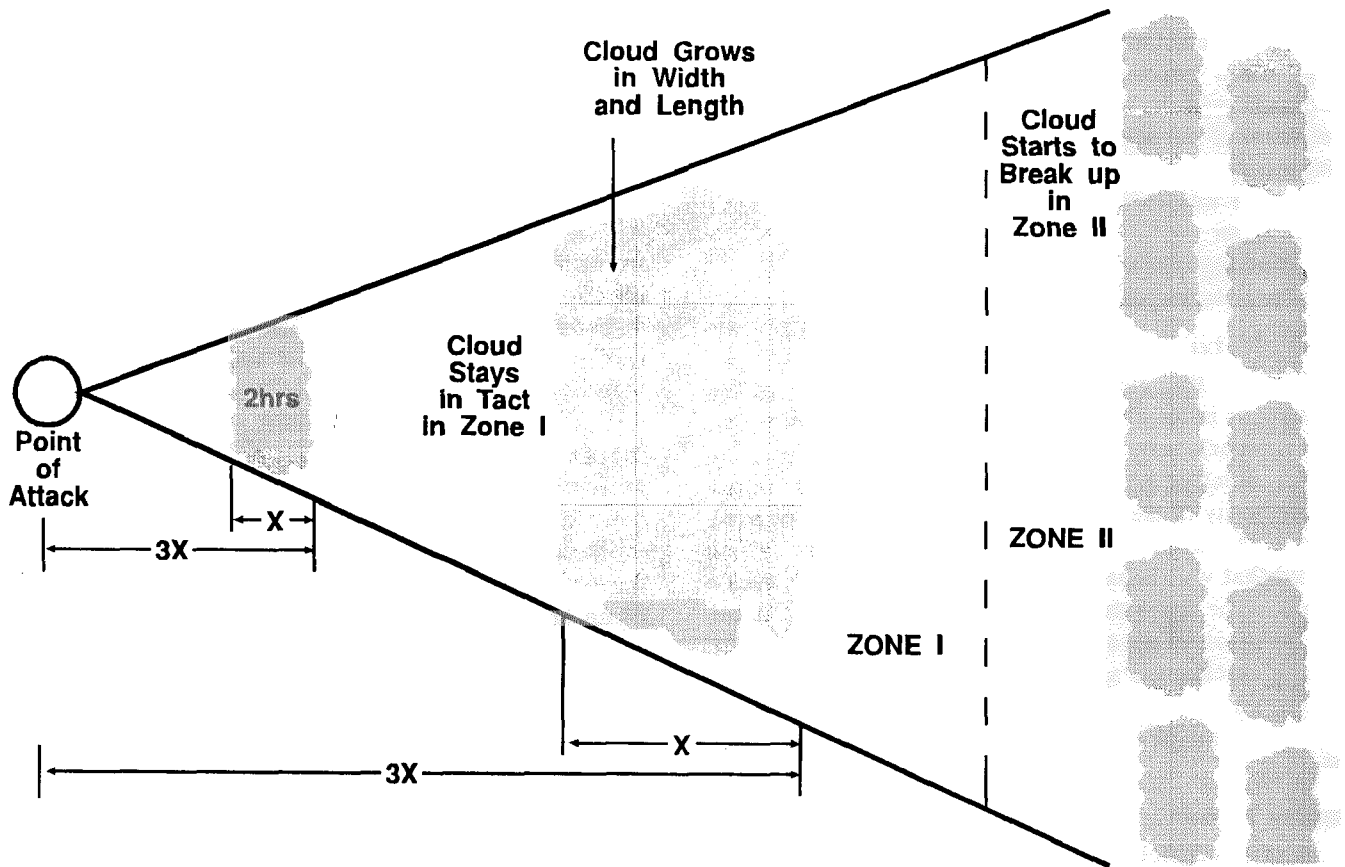

Figure 4-1. Downwind Movement and Characteristics of a Biological Agent Cloud.

casualties can occur in an area as much as two times the maximum downwind hazard distance for a chemical agent. Traveling farther downwind, the cloud is exposed to environmental elements. It is subjected to dispersal and settling and impaction on terrain features. The agent cloud will lose much of its concentration and the losses will be such that the majority of unprotected personnel will not receive an infective (pathogen) or effective (toxin) dose. However, dispersal will not be uniform and casualties may occur as far as four to five times the maximum downwind hazard distance of chemical agents. The following two examples illustrate biological aerosol strength:

- If the infective dose of a particular agent is one organism and there is a concentration of just one organism per 5 liters of air, the average soldier, breathing at a rate of 15 liters/minute, can breathe in three times the infective dose in one minute.
- It has been calculated that as little as 2 to 3 grams of tularemia bacteria *Francisella tularensis* (causative agent of rabbit fever) may be sufficient to create a bacterial aerosol 100 meters high and extending over an area 1 square kilometer. This can infect humans, breathing at a normal rate, with 100 minimum infective doses per minute.

Knowing biological cloud behavioral characteristics, units may calculate the approximate cloud arrival time and cloud exposure time. This provides both an estimation of the exposure period as well as the time of exposure if the point of attack has been identified. This information is presented later in this chapter.

There are two primary aerosol dissemination techniques:

- Bursting type munitions.
- Spray tanks/generators.

### **Bursting type munitions**

When a biological projectile or bomb bursts on the ground or in the air, the filling (either a liquid slurry or dry powder), is initially dispersed in all directions.

An effective ground bursting munition, will project the majority of the filling into the air to form an aerosol cloud. Air bursting munitions may also form an aerosol cloud that will behave in a similar manner to a spray attack. The agent may however, also be designed to fall to the ground as a surface contaminant much like persistent chemical agents.

The dimensions of the aerosol cloud will be influenced by the means of delivery, the weather conditions, and the terrain.

### **Spray Tanks/Generators**

Aircraft/vehicle spray tanks, or aerosol generators, may also be employed to form an aerosol cloud. This

form of attack is likely to take place as covertly as possible. Tactical attacks (those directed at specific units or elements on the battlefield) with biological agents are likely to occur at altitudes of approximately 300 meters or less. Determining the hazard areas resulting from biological agent dissemination at altitudes of greater than 300 meters will require in-depth meteorological analysis and is therefore beyond the capabilities of most units. The simplified biological downwind hazard prediction (SBDWHP) pertains to aerosol disseminations that occur at or below 300 meters above ground level. Biological agents may also be disseminated as a liquid (such as "yellow rain") and the hazard generated by this means of delivery will be limited to the area of attack.

### **Zones of Contamination**

After its initial formation, the aerosol cloud will travel downwind. The agent cloud will lengthen and widen. While it is highly concentrated, it will cause a high number of casualties (immediate or delayed) among unprotected personnel (approaching 100% with some agents). The area in which casualties among unprotected personnel will be high enough to cause significant disruption, disability, or elimination of unit operations or effectiveness is defined as Zone I. Priority medical treatment may be required for individuals exposed to the Zone I hazard. Units in this zone should increase their protective postures during the period of greatest hazard or upon alert if near the attack area. Units should be able to calculate this period using the equations for cloud arrival and cloud exposure times.

After traveling downwind, exposure to the elements will disperse the aerosol cloud to a degree at which the majority of unprotected personnel will not receive an infective (pathogen)/effective (toxin) dose. However, dispersal will not be uniform, and casualties may occur relatively far from the point of attack. This area of reduced, but definable hazard is Zone II. Personnel in this zone may assume a limited protective posture, including the protective mask, wearing work or protective gloves, buttoning up the uniform, rolling down uniform sleeves, and covering or bandaging any exposed cuts or scratches. Monitoring of personnel in Zone II for symptoms/effects of BW agents is required. Zone II includes all areas in which hazards to unprotected personnel are likely to exceed negligible risk levels under an aerosol disseminated attack. This zone may be very large; under some conditions encompassing thousands of square kilometers. Dividing the hazard areas into zones allows commanders to weigh the tactical considerations against performance degradation of MOPP with some knowledge of the relative risks. The end line for Zone I is the 20-30% casualty line and the end line for Zone II is the 1-3% casualty line. Figure 4-2

shows casualty probability curves for both Zone I and Zone II. It is important to note that the curves will be different for each agent and will depend greatly on the weather conditions that exist at the time of dissemination.

**Aerosol Avoidance Procedures**

**Before the attack**

- Establish and enforce preventive medicine programs to include immunizations, area sanitation and personal

hygiene standards, and rest and nutritional needs of the troops.

- Gain intelligence on threat capabilities and intentions.
- Seek out, intercept, and destroy enemy weapon systems, production facilities and storage sites.
- Instruct troops on the threat and recognition of the attack and protective measures.
- Train and drill on fitting and putting on protective mask and clothing.
- Set up collective protection systems for personnel, equipment, and supplies. (NOTE: Field expedient

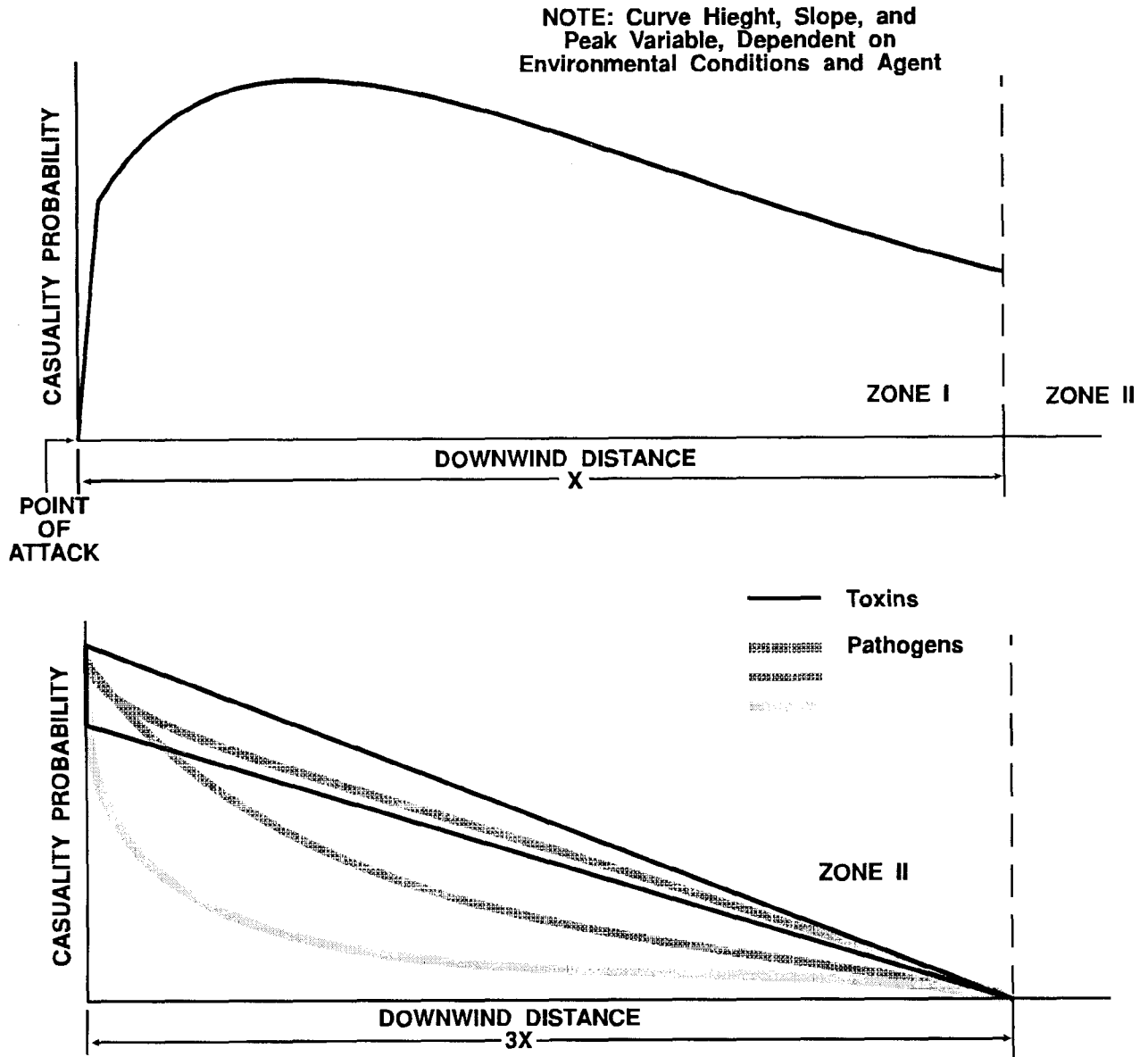

Figure 4-2. Biological Casualty Probability Curves for Zone I and II.

collective protection must be airtight.)

- Identify backup (alternate) food, water, and supply sources.
- Establish detection and sampling procedures.
- Conduct vulnerability analysis.

#### **During the attack:**

- **Recognize the attack.**
- Initiate personnel protective measures. Masking is the first priority, but since the attack may be chemical or toxin, MOPP 4 is required initially. For maximum protection and the lowest risk of incurring casualties, soldiers should wear protective clothing and mask for at least 4 hours after the unit has been attacked or the agent cloud is predicted/known to have passed through the unit area. Every effort must be made to identify the exact agent, including its characteristics. If the skin is contaminated, remove contamination immediately with large amounts of warm soapy water (if available) and decontaminate the skin with the M258A1 kit or M291 kit. (FM 3-5, Chapter 2, has detailed instructions on skin decon).

- Repulse or eliminate delivery vehicle or weapons.
- Observe for distinguishing signs between biological and chemical agent attack or a mixture of conventional and biological attack.
- Report the attack utilizing the NBC Warning and Reporting System (NBCWRS). (A biological attack that can not be immediately identified will be reported as an NBC 1, agent unknown or Suspected Biological Report).

#### **After the attack:**

- Estimate the downwind hazard (significant casualties in unprotected personnel can be at least two times the maximum downwind hazard distance for a chemical agent).
- Begin sampling/collection procedures IAW unit SOP.
- Consume only sealed rations and properly contained water (outer container surfaces, if exposed, must be properly decontaminated. See FM 3-5). Call preventive medicine personnel when safety of unit level water supplies are questionable. Ensure veterinary personnel inspect food storage depots and supply points. Replenish water supplies from water purification units.
- Separate biological casualties. Use minimum number of personnel (to limit exposure) to provide supportive medical care until evacuation.

## **Vector Dissemination Procedures**

Some pathogens may be delivered by use of arthropods and other vectors such as fleas, ticks, lice, and mosquitoes. Bulk container aircraft dissemination or

small cage vector bomblets can be used. The enemy may use vectors to circumvent the protective mask or MOPP gear. Any experienced field soldier or outdoorsman knows the tick is capable of crawling under even the most constrictive clothing. Some flying insects can travel considerable distances against prevailing winds. This makes dissemination patterns hard to determine. Some pathogens can remain within the infected vector for the life of the vector, so biological hazards can be prolonged (one to two months for some mosquitoes and six to seven months for some fleas). If the enemy decides to use vectors, control is a limiting factor. Of course, frigid temperatures that may kill the vectors, will also have an effect. This dissemination method also limits the enemy because he has no way of controlling the vectors once they have been released. Logistical and production problems can arise in the delivery of a live pathogen inside a living vector in sufficient quantities to be an effective weapon. The prediction of hazard areas caused by vector dissemination is virtually impossible based on the unpredictability of the vectors.

### **Vector Avoidance Procedures**

#### **Before the attack:**

- Apply insect repellent on exposed skin.
- Gain intelligence on threat capabilities and intentions.
- Seek out, intercept, and destroy enemy weapon systems and production and storage sites.
- Instruct troops on the threat, recognition of the attack, and protective measures.
- Establish and enforce preventive medicine programs to include immunizations, area sanitation, personal hygiene standards, rest and nutritional needs of the troops.

#### **During the attack:**

- Recognize and report suspicious indications of the vector attack (the sudden appearance of large numbers or strange kinds of insects not previously encountered in an operational area or the finding of vector bomblet cages).
- Cover exposed skin. Balance between protection and degradation of performance. Protective overgarments will not totally exclude the determined tick. Bloused trousers and rolled down and buttoned sleeves with insect repellent properly applied will probably afford as much protection with less degradation.
- Apply insect repellent liberally—especially to neck, face, ankle, and wrist areas.
- Report the attack.

#### **After the attack :**

- The NBCC should coordinate with the supporting medical authority for preventive medicine assistance.



- Begin insecticide and other pest control measures as outlined by preventive medicine personnel. Logistical support for unit-size pest control procedures should be a coordinated effort between the NBCC and the supporting medical authority. Physically remove body lice, ticks, and fleas by self aid and buddy aid as necessary.

- Make hazard estimates. Recon and medical reports may help the NBCC in assessing hazard areas.

## Convert Dissemination and Avoidance Procedures

Sabotage and terrorist personnel may possess a variety of aerosol and contamination/poisoning techniques for various targets. Aerosol techniques can be fairly large operations, using aerosol generators (or foggers) that produce large open-air hazard areas. These techniques also can be more limited and selective, targeting the enclosed air space of key command and control facilities, aircraft, ships, troop billets, and other similar type areas. Biological agents in liquid, powders, or spray can be placed directly into food stuffs at harvest, processing, distribution, and preparation points. They can be placed into the water reservoir/distribution chain.

### Before the attack:

- Maintain OPSEC.
- Identify covert/sabotage threat force capabilities and intentions through intelligence.
- Arrange for security measures to be taken based upon threat assessment.
- Identify alternate supply sources for those high-risk items.
- Instruct troops to be alert to dissemination devices or signs of covert tampering as intelligence dictates.
- Establish and enforce preventive medicine programs to include immunizations, area sanitation, personal hygiene standards, and rest and nutrition needs of the troops. (NOTE: Based on intelligence, protection of food and water may prevent successful employment of a specific biological agent.)

### During the attack:

- Report the observation of an attack, the apprehension of enemy agent(s) engaged in such activity, or the finding of signs and indications of covert attacks.
- Initiate personnel and collective protection. For maximum protection and the lowest risk of incurring casualties, soldiers should maintain this protective posture for at least 4 hours.

### After the attack :

- Warn personnel downstream, downwind, and/or down supply lines. The NBCC will do so based on

at-hand medical and intelligence information and analysis of NBC 1 Reports.

- In conjunction with the veterinary and surgeon general initiate disposal and replacement of food, water, and other supplies. The NBCC can coordinate inspections and medically approved replenishment sources. Actions involving disposal of major quantities of food must be coordinated with the supporting veterinary personnel. Actions involving disposal of major quantities of other nonmedical supplies should be coordinated with the NBCC.

- Initiate sampling based on knowledge, consent, and special sampling requirements of the NBCC. If a BW attack is suspected, wash surfaces with at least a 5% solution of bleach. Bleach is a very effective form of decontamination for most BW agents.

## Warning and Reporting

Determining that a biological attack has occurred will pose considerable difficulties for soldiers. There are the usual indicators of CB attack, such as low flying aircraft spraying mists or fogs, munitions with little or no explosive effect, or ground generators spraying a fog or mist, all during the "windows of vulnerability". But even if fortunate enough to observe the attack, the field soldier will not be able to distinguish a biological attack from a chemical attack.

The NBCWRS is used to report biological attacks. However, the number of potential agents, the various dissemination methods and techniques, and the lack of automated detection and identification devices have thwarted an all-encompassing simplified biological hazard prediction. So, the use of the NBCWRS will be extremely limited. Until intelligence and prior experience come into play, it is unlikely that biological reports will go past the NBC 3 Report.

Observed attacks will be transmitted (most likely) by the NBCC as an NBC 1 Chemical Report, agent unknown or NBC 1 Suspected Biological Report. Upon receipt of the initial NBC 1 Report, the NBCC will send an NBC 3 Chemical Report.

Reports from units in the immediate attack area will help determine the nature of the attack. The observation of two events in the attack may indicate a biological rather than a chemical attack. An attack that has no apparent immediate effect on birds, animals, insects, or unprotected personnel could indicate a pathogen attack or delayed action toxin especially if the attack occurs during the "window of vulnerability". Observation of immediate effects coupled with a lack of detection/identification of a chemical agent could indicate a rapid-acting toxin attack. This information should be transmitted on a follow-up NBC 1 Report.

The observations should be reported on line Zulu Bravo. The report is then sent to all units in the division/corps operational area as an NBC 3 Suspected Biological Report. In order to send an NBC 3 Suspected Biological Report, the NBCC will have to analyze the nature of the attack as well as other information available. Presume that a biological attack has occurred based on the following factors:

- Analysis of NBC 1 Chemical Follow-up Reports.
- Analysis of intelligence data regarding enemy capabilities, tactics, and activities.
- If attack occurs during the “window of vulnerability”.
- Analysis of preliminary laboratory examinations or completed reports from past attacks (NOTE: Complete agent identification may take days or longer).
- precognition of a pattern of established warfare.
- Analysis of samples
- Onset of symptoms related to biological agents

Units use NBC 3 Suspected Biological Reports as battlefield intelligence. With knowledge of the biological agent aerosol cloud characteristics, units can approximate the area in relation to the simplified downwind hazard prediction of a chemical agent. Figure 4-3 and 4-3a depict a flow chart for the agent identification as it pertains to biological attacks. Figure 4-3 represents the role of field units (Bn and below). The process begins with the observation of a suspicious attack. If the unit is unable to immediately identify the agent they will then generate an NBC 1 Agent Unknown Report (circle A, Figure 4-3). The NBC 1 Report is forwarded to the NBCC (circle A, Figure 4-3a) and an NBC 3 is generated assuming an unknown chemical attack. This NBC 3 is transmitted back to the field unit (circle D, Figure 4-3a). The unit will receive the NBC 3 Report (circle D, Figure 4-3) and take the appropriate defensive measures. The field unit will continue to attempt to identify the agent and will send an NBC 1 follow up Report based on its findings for either a known or unknown agent (circles B, Figure 4-3). The NBCC will process the NBC 1 follow up Reports (circle B, Figure 4-3a) and evaluate the data. If a biological attack is suspected the NBCC will issue an NBC 3 Suspected Biological Report (circle D, Figure 4-3a). The affected unit will take the appropriate defensive measures (circle D, Figure 4-3a) and plan and conduct sampling operations IAW unit SOP (circle C, Figure 4-3). Sampling should be conducted by trained personnel, usually chemical infrastructure personnel trained in sampling techniques.

After a unit (Bn or lower) receives an NBC 3 Suspected Biological Report from higher, they may be directed to perform a sampling operation. The unit will

report its data in an NBC 4 format with line Hotel specifying that the agent is unknown. Once the higher headquarters receives confirmation of the samples contents they will transmit an NBC 5 based on the previous data from the submitted NBC 4's. The final NBC report is the NBC 6 Biological Report. It is a narrative description of biological attacks that have occurred in the reporting units' area of operation. It is written at the battalion level or above. The NBC 6 Biological Report contains as much information as possible about the attacks. It is submitted only when requested and is sent hard copy. Figure 4-4 shows examples of biological reports.

In some cases the NBCWRS may have to be modified for a biological attack. This will occur when:

- The “windows of vulnerability” are present for the optimum weather conditions.
- Observation of suspicious activity by the enemy (e.g., low flying aircraft or generators emitting a vapor or powder substance).
- Area sampling teams, equipped with air samplers and Elisa tickets as outlined in Chapter 5, in pre-planned positions obtain a positive sample or test for a biological agent.
- When the conditions occur, the area sampling team will prepare an NBC 6 Suspected Biological Report and send the report to the NBCC. The sample is evacuated for laboratory analysis. The NBCC will:
  - Plot the sampling teams position on the situation map.
  - Prepare and disseminate an NBC 3 Suspected Biological Report.
  - After laboratory analysis confirms that the sample taken is a biological agent, the NBCC will determine the pattern of deposition and decay rate for the agent. This may be accomplished by receiving other sampling reports within the area, developing a pattern based on information gathered from medical or intelligence sources, or by the simplified techniques for downwind hazard prediction outlined in this chapter. Once this area of deposition is defined by the NBCC, the NBCC will prepare and disseminate an NBC 5 Biological Report.

## Principles of Hazard Prediction

When a chemical or biological agent is employed as an aerosol, there will be an initial, lethal concentration of agent in the area employed. The agent will form a cloud that will be carried downwind, spreading at a 30 degree angle to either side of the wind direction. The

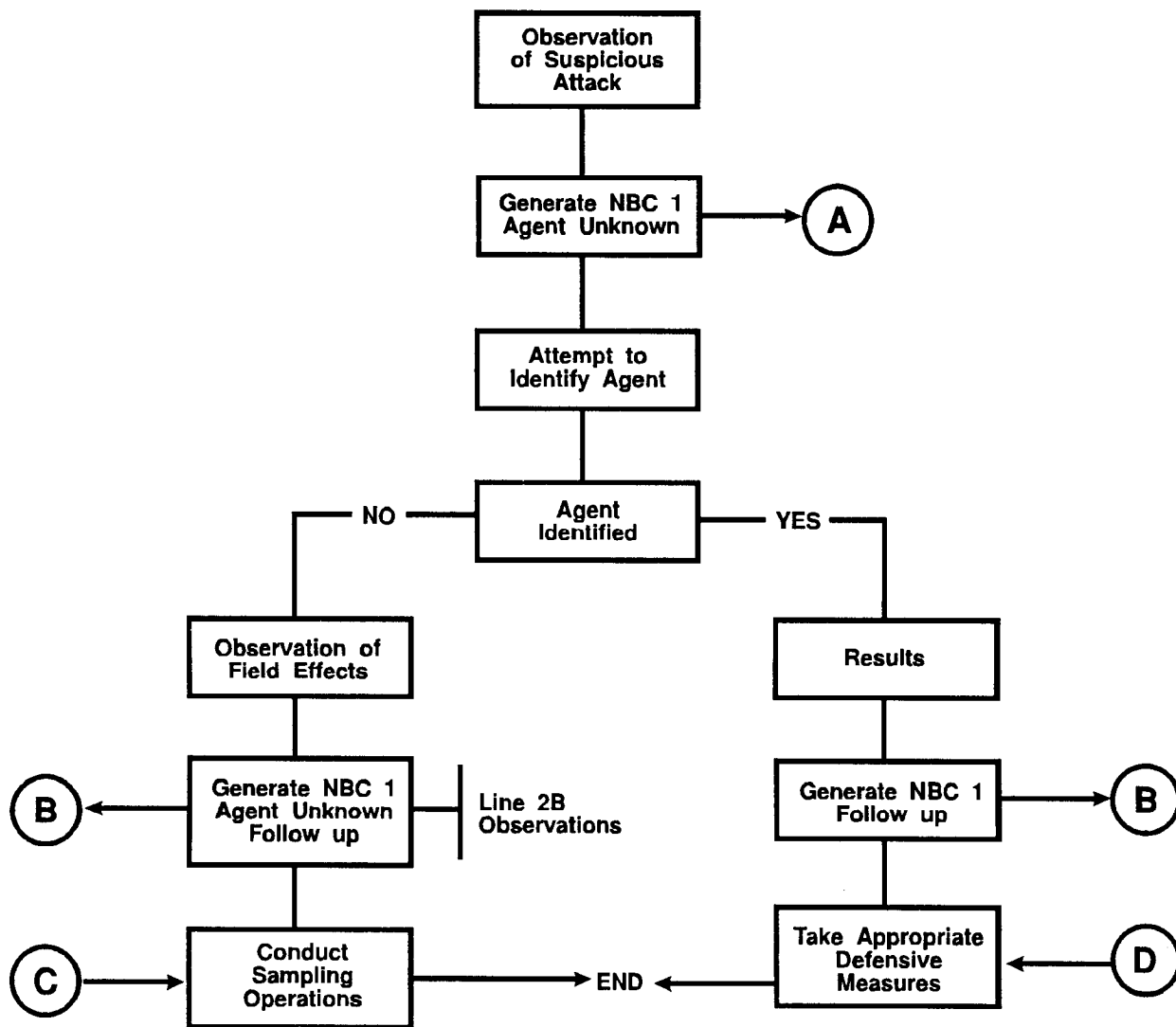

Figure 4-3. Flow chart for biological attack identification Part 1. Role of field units.

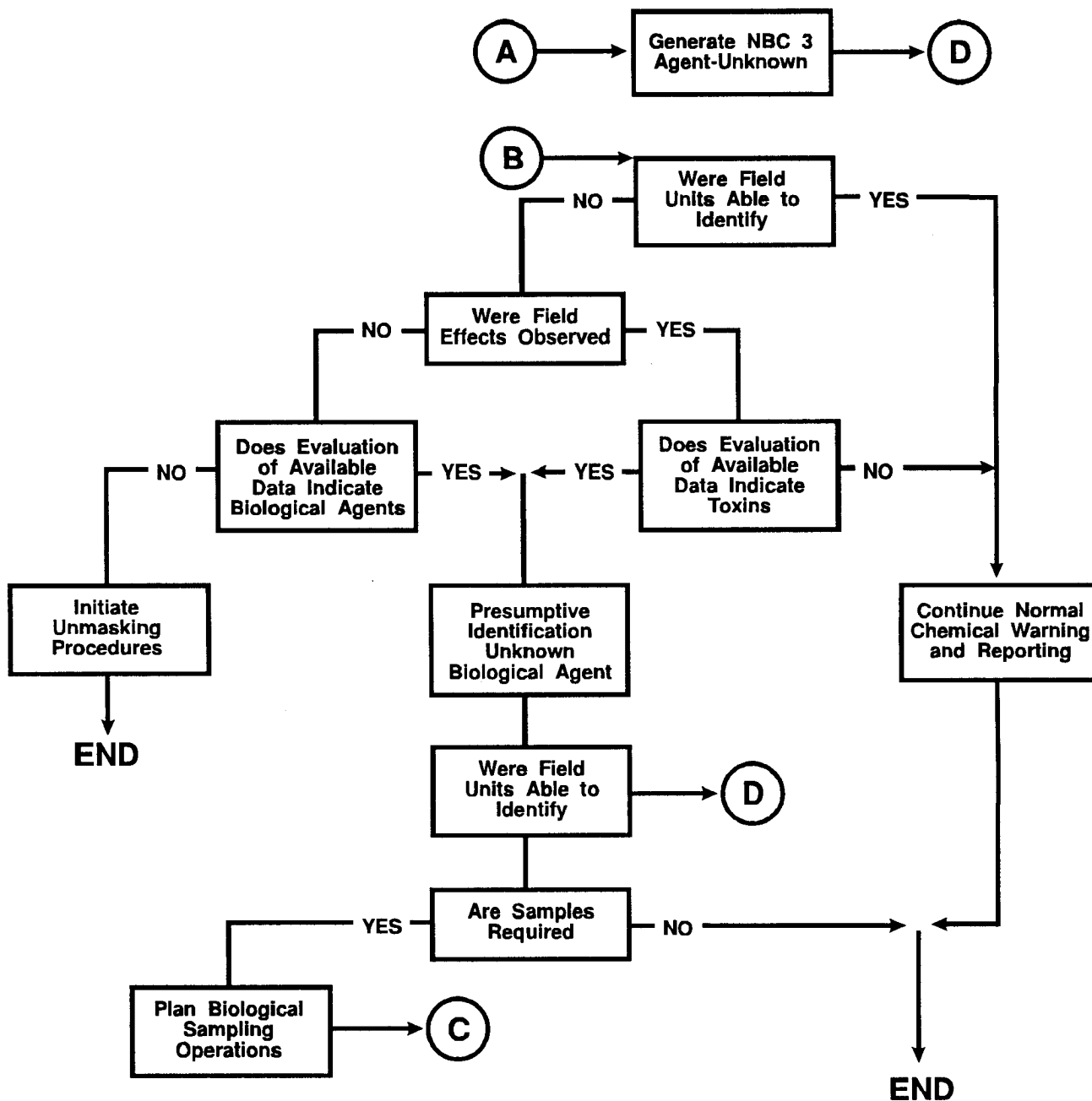

Figure 4-3a. Flow chart for biological attack identification Part 2. Role of NBC center.

NBC 1 Chemical (Attack observed that could be chemical or biological)	NBC 1 Follow-up (Observations indicating biological)
<p>B LB200300 D 200430Z E 200435Z F LB200300 Actual G Aerial Spray H Unknown</p> <p>NBC 3 Chemical A C001 D 200430Z F LB200300 to LB208304 Actual G Aerial Spray H Unknown PA LB216298, LB203290, XX700000, XX700609, LB213313 (XX Left Adjacent Gridzone) Y 0270 Deg, 015 kmph ZA 6158-0</p> <p>NBC 4 Suspected Biological H Unknown-Suspected Biological Q LB200300, Liquid S 200530Z</p>	<p>B LB200300 D 200430Z E 200435Z F LB200300 Actual G Aerial Spray H Unknown-Suspect biological ZB M8 and M256 negative detection/identification. Masked personnel and cattle staggering, collapsing — paralyzed and dying.</p> <p>NBC 3 Suspect Biological A C001 D 200430Z F LB200300 to LB208304 Actual G Aerial Spray H Unknown-Suspect biological PA LB216298, LB203290, XX700000, XX700609, LB213313 Y 0270 Deg, 015 kmph ZA 6158-0 ZB Line PA is maximum casualty area. Significant casualties with unprotected personnel four times this downwind area possible.</p>

FIGURE 4-4. Examples of biological reports.

wind will then carry the agent and dissipate it. The length of the cloud is approximately 1/3 of the total distance traveled. As the cloud increases in width and length, the actual exposure hazard will increase, because although the concentration of the cloud has decreased the exposure time will be greater due to the increased size of the cloud. Therefore troops will be exposed to a lower concentration of agent, but for a longer period of time. The cloud is expected to produce at least a 20% casualty rate for exposed, unprotected troops in Zone I. In time, the cloud dissipates (and the agent degrades) to the point at which it can no longer produce casualties. In Zone II, the casualty rate for exposed, unprotected troops is less than 20%, but greater than 1-3%. Beyond Zone II, less than 1-2% of exposed troops are expected to be casualties. There are three questions of tactical importance to both commanders and troops in the field

1. Will personnel be exposed? A prediction of this is Zone I and II areas defined by the SBDWHP.

2. At what time will troops be first exposed to the agent? This can be found from the cloud arrival time (CAT), the time when the aerosol cloud will first reach a unit. CAT is calculated by:

CAT = cloud arrival time  
TOA = time of attack

$$CAT = TOA + \frac{\text{Distance (km) from attack area}}{\text{windspeed (kmph)}}$$

3. How long will troops in the area be exposed? This

can be found from the cloud exposure time (CET), the total time that a unit will be within the cloud. CET is calculated by:

CET = cloud exposure time (in hours)

$$CET = \frac{\text{distance (km) from attack wee}}{3 \times \text{windspeed (kmph)}}$$

## Simplified Downwind Hazard Prediction for Biological Agents (SBDWHP)

Downwind hazard prediction for biological agents is very similar to the procedure for chemical agents. The resulting prediction provides a minimum estimate of the danger zones for biological agents in general. After employment, actual sampling by trained personnel will produce a better indication of the areas affected.

Indications of a biological attack: You should suspect a biological attack when 1) there are indications of a chemical attack, but no effects, and 2) a presumed chemical attack has occurred, but the agent has not been identified. In the first case, soldiers would observe such enemy activities as low flying aircraft or generators spraying mists or fogs, or munitions detonating with little or no explosive effect. There would be no

symptoms of a chemical attack, however. In the second situation, there would be the effects of a chemical attack such as casualties among unprotected troops, but the agent cannot be identified with standard detection equipment.

In both cases described the unit observing the attack will submit an NBC 1 Chemical Report, agent unknown, to the NBCC. Soil, liquid, and surface samples should be collected and sent to servicing identification laboratories as quickly as possible, when directed by the NBCC.

Upon receipt of the initial NBC 1 Chemical Reports, the NBCC will issue an NBC 3 Chemical Report to alert units in the immediate downwind hazard area. The NBC 3 Chemical Report equates to approximately 50% of the Zone I of the Simplified Biological Downwind Hazard Prediction (SBDWHP). This warning will be adequate for the first 1 to 5 hours (dependent on windspeed); the units in the remainder of Zone I and Zone II of the biological hazard will need to receive an NBC 3 Biological Report for adequate warning.

The hazard area prediction will be less reliable as the distance and time from the point of attack increases (If the wind changes, follow the same procedures for recalculation as for chemical hazard prediction.

Units in the downwind hazard area will not be able to detect arrival of the aerosol cloud. Thus, no NBC 4 Biological Reports will be generated. Downwind units should collect soil, liquid and surface samples at various times following calculated cloud time arrival, as directed by NBCC. These samples will be handled through the technical intelligence chain. This will allow determination as to where the downwind hazards actually occurred.

Due to the infectious nature of pathogens, close co-operation and coordination between medical and maneuver units will be required to limit and control the effects of biological attacks. Biological agents could be re-aerosolized by vehicle traffic, etc., in the downwind hazard area, especially Zone I.

**Hazard Prediction**

Three kinds of Biological attacks will be discussed.

a. Type A Case a: a point-source attack (ex: aerosol generator, bomb) or an area attack (as in artillery or bomblet attack). This type of attack is also used for toxins.

b. Type A Case b: a spray-line.

c. Type B: A large liquid drop/ground contaminating attack.

The following information is required:

- NBC 1 Chemical (Initial report will indicate unknown chemical)
- Chemical Downwind Message

- Being Morning Nautical Twilight (BMNT)

**Cloud Duration of the Greatest Effects (Zone 1)**

Engineered/Hardened Pathogens	# of hours from time of attack to BMNT + 2 hours.
Nonhardened Pathogens	Max 8 hours.
Toxine	8 hours

Type A Case a (point Source Attack and Toxins)

All attacks that occur during daytime and all toxin attacks will be presumed to have a cloud duration of the greatest effects of 8 hours. Only for night attack is it necessary to compute this duration.

The 8 hour maximum for cloud duration is based upon agent decay by environmental conditions, particle fall, and cloud dissipation. The actual effectiveness to minimum hazard levels may extend to as much as 32 hours. [Four times (4X) the cloud duration of greatest effects.]

1. Derive the location of the attack from NBC I Chemical Report and plot the location on a map or template.

2. Draw a 1 km circle around the point of attack.

3. Determine the maximum Downwind hazard (MDWHD)

$$MDWHD = 4 \times \text{Windspeed (kmph)} \times \text{Cloud Duration* of greatest effects (Zone I)}$$

\* The cloud duration is a measure of the length of time a biological agent is likely to remain effective and aerosolized in the environment.

4. Draw a line from the point of attack along the representative downwind direction, equal in length to the MDWHD (example #4, step 4).

5. Draw a line perpendicular to the representative wind direction, intersecting the point of the MDWHD (example #4, step 4).

6. Extend the line along the representative wind direction for a distance twice the radius of the circle around the attack area from GZ in the direction behind the attack area (example #4, step 5).

7. From the rear endpoint of the representative wind direction line, draw two lines that intersect this point, are tangent to the attack area circle, and intersect the line of MDWHD (example #4, step 6).

8. Erase the area behind the attack area circle. The remaining area constitutes the Zones I & II hazard area. The points shown on the diagram define the hazard area. Indicate these points on line PA of the NBC 3 Report.

9. Divide the MDWHD by 4. Plot this distance along the representative wind direction line. Draw a line perpendicular to the representative wind direction and which intersects both tangent lines at this point. The area within this smaller plot is the Zone I hazard area (example #4, completed diagram).

Example of full downwind hazard prediction (see

diagrams for step by step solution).

10. Report the two points at which the Zone I hazard line intersects the tangent lines on line ZB of the NBC 3 Biological Report.

**Example 1:** Time of attack: 0130  
 BMNT: 0430  
 wind direction: 150 grid  
 windspeed: 15 Km/Hr  
 cloud duration = 5 hrs MDWHD =  $4 \times 15 \times 5 = 300$  Km  
 (3 hours from time of attack to BMNT + 2 = 5 hours)

**Example 2:** Time of attack: 1130  
 BMNT: 0600  
 wind direction: 75 grid  
 windspeed: 10 Km/h  
 MDWHD =  $4 \times 10 \times 8 = 320$  Km  
 (6.5 hours from time of attack to BMNT + 2 = 8.5; which cannot exceed 8 hours)

**Example 3:** Time of attack: 0430 (Toxi,n presumptive identification)  
 BMNT: 0530  
 windspeed: 12 Km/h  
 wind direction: 60 deg grid  
 MDWHD =  $4 \times 12 \times 8 = 384$  Km  
 (All toxin attacks have cloud duration of greatest effect of 8 hours)

**Example 4:** Time of attack: 0330  
 BMNT: 0530  
 windspeed: 13 Km/h  
 wind direction: 90 deg grid  
 MDWHD =  $4 \times 13 \times 4 = 208$  Km  
 (2 hours from time of attack to BMNT + 2 hours = 4)

**Type A Case a (area attack)**

1. Derive the location of the attack from NBC 1 Chemical Report and plot it on the map.

2. Plot a circle with a radius of 1 Km, unless the attack area radius is known to be more than 1 Km. If the attack area is known to be greater than 1 Km, then plot a circle with a radius equal to the radius of the attack area around the center of the attack area. The circle must have a minimum radius of 1 Km.

3. All subsequent procedures are exactly as outlined in Type A Case a point source sample. (See diagrams for Step by step solution).

**Example 5:** Time of attack: 2230  
 BMNT: 0700  
 windspeed: 15 Km/h  
 wind direction: 60 deg grid  
 MDWHD =  $4 \times 15 \times 8 = 480$  Km  
 (maximum 8 hours BMNT)

**Type A Case b (linear spray)**

1. Derive the location of the attack area from NBC 1 Chemical Report. (A number of reports may need to be evaluated). Plot the attack area or spray line on the map. Draw a line through the attack area from the start point to the end point (example #6, step 1).

2. Draw a 1 Km circle around the beginning point and endpoint of the spray line (example #6, step 2).

3. Determine the MDWHD, as in Case a.

4. From each endpoint of the sprayline, draw a line equal in length to the MD along the representative downwind direction (example #6, step 3).

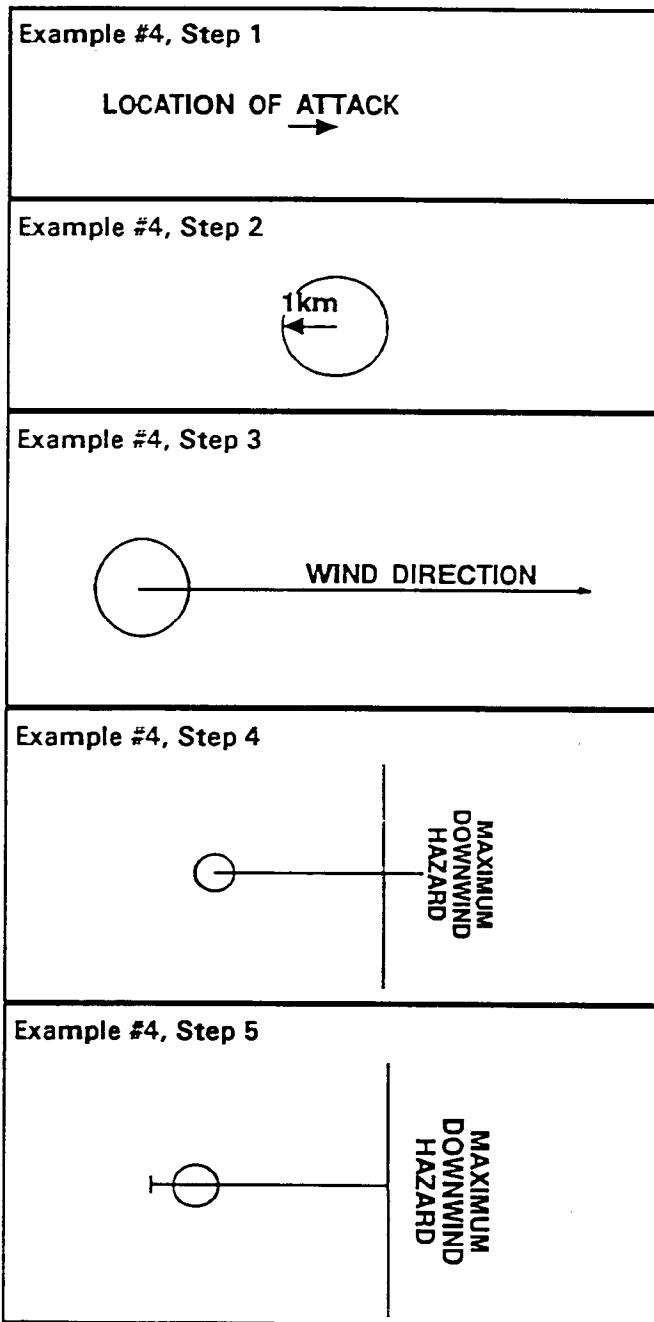

Example #4, Step 6

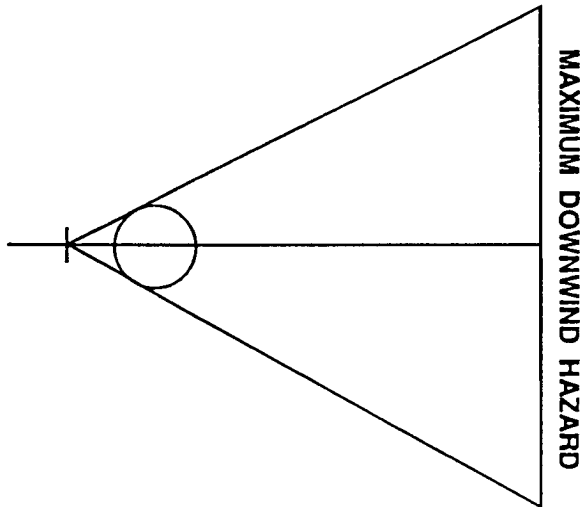

Example #4, Completed Diagram

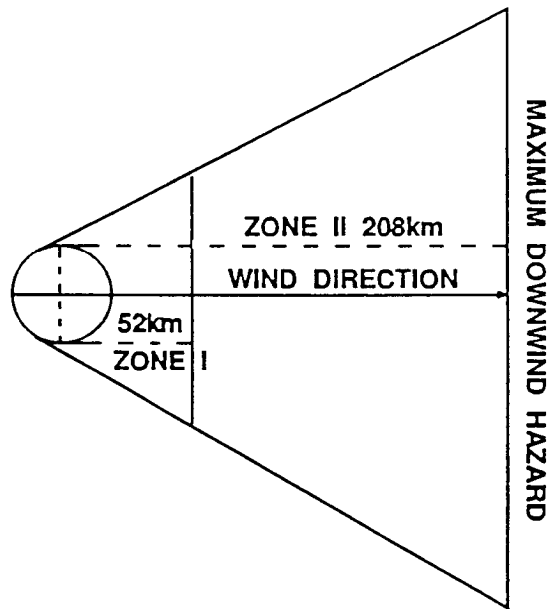

5. Draw a perpendicular line intersecting the MDWHD point on the representative wind direction line drawn from the attack area endpoint furthest downwind (This is the line of Maximum Downwind Hazard - example #6, step 4).

6. Extend each representative wind direction line 2 km behind each endpoint of the spray line (example #6, step 5).

7. Draw a line from each point 2 Km behind the endpoints tangent to the outer side of each circle, until it intersects the MDWHD line. (example #6, step 6).

8. Draw a line tangent to the rear of both attack

circles. Erase any area behind the attack circles. This figure encompasses the Zone II hazard area. Report the points delineating this area. (See figure on line PA of NBC 3 Reports (example #6, step 6).

9. Divide the MDWHD by 4. Plot this distance from the attack area endpoint furthest downwind on the representative wind direction line. Draw a line perpendicular to this point which intersects both tangent lines. This smaller figure is the zone I hazard area. Report the point of intersection with the tangent lines as Zone I on line ZB of the NBC 3 Biological Reports (example #6, step 6).

Example 6: Time of Attack 0930 (See diagram for step by step solution).

BMNT: 0700

wind speed: 12 Kmph

wind direction: 90 deg grid

spray length: 10 Km

MDWHD =  $4 \times 12 \times 8 = 384 \text{ Km}$

Type B (Large Liquid Drop/  
Ground Contaminating Attack)

1. Derive the location of attack area from NBC 1 Chemical Report and plot it on the map.

2. Draw a circle with a radius equal to the radius of the attack area. This circle should have a minimum radius of 5 Km.

3. Report the hazard area as three digits on line PA of NBC 3 Biological Report.

## Sampling

Sampling aids in the identification of an agent and enhances determination of medical treatment required. Obtain a large amount of agent relatively free of interfering materials. Sampling identifies which agents were used in an attack. Identification can aid in -

- Confirming that an attack has taken place.
- Determining the proper therapy for personnel exposed to the agent.
- Estimating the possible number and type of casualties.
- Determining the time-to-casualties if time of the attack is known.
- Evaluating an enemy's biological capability.

Sampling should be conducted by trained personnel. (These are chemical infrastructure and NBC recon personnel specifically; but by prior coordination in SOPs and OPLANs, intelligence or medical technical assistance and/or specific advice could be rendered.) Trained personnel ensure uniformity, viability, safety, and accountability in sampling procedures. Sampling is not done indiscriminately, but only when an attack is indicated. Sampling operations, other than medical



Example #5, Step 1 (Type A, Case A, Area Attack)



Example #5, Step 2

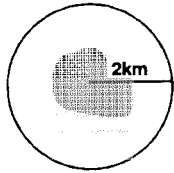

Example #5, Step 3



Example #5, Step 4

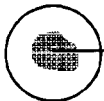

MAXIMUM DOWNWIND HAZARD

Example #5, Step 5

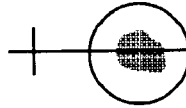

MAXIMUM DOWNWIND HAZARD

Example #5, Step 6

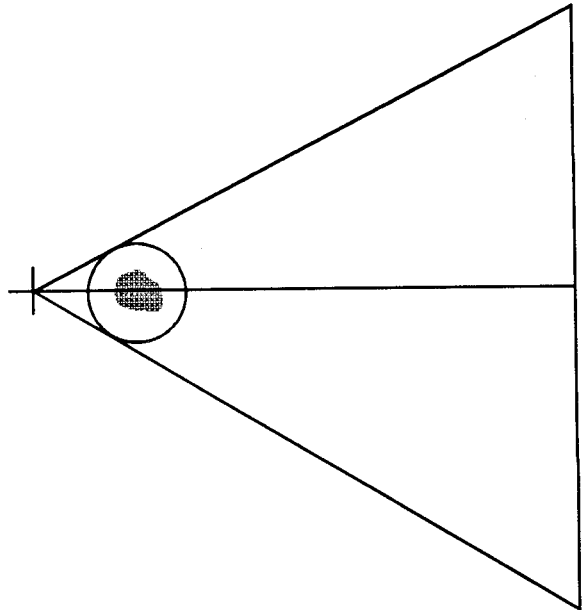

MAXIMUM DOWNWIND HAZARD

Completed Example #5

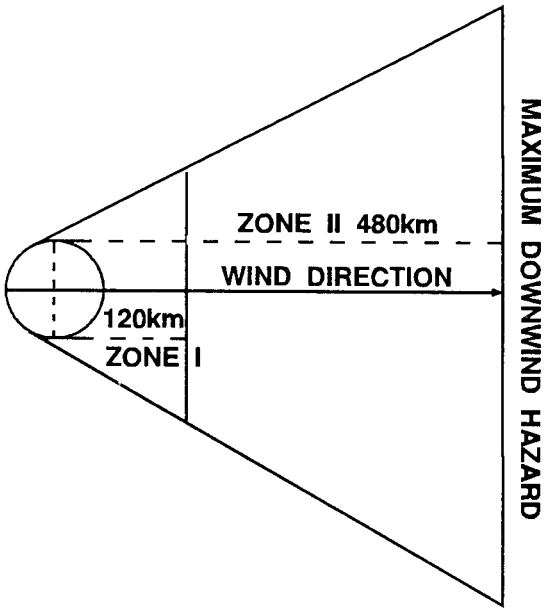

Example #6, Step 3

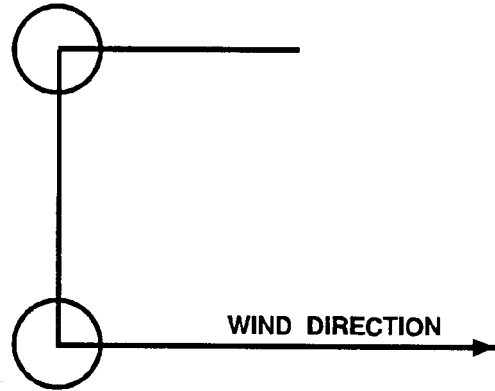

Example #6, Step 4

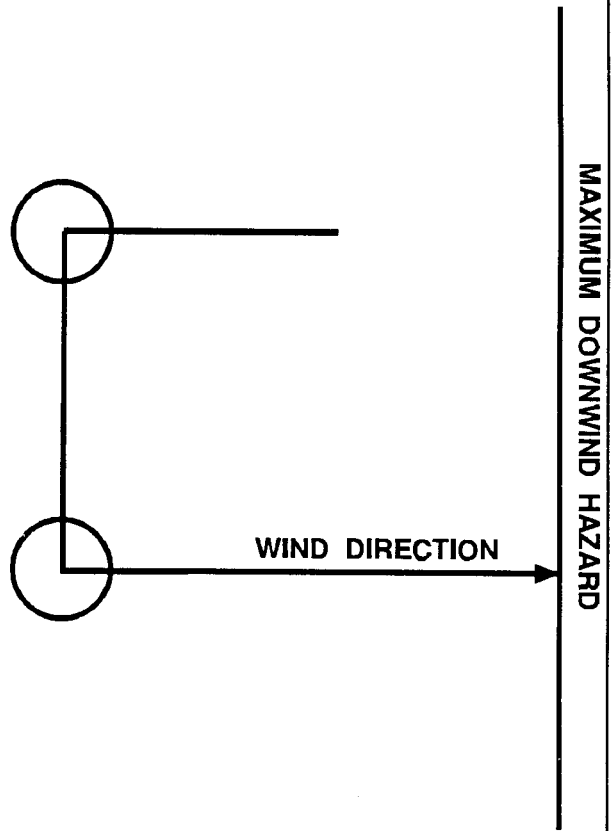

Example #6, Step 1  
(Type A, Case b)



Example #6, Step 2



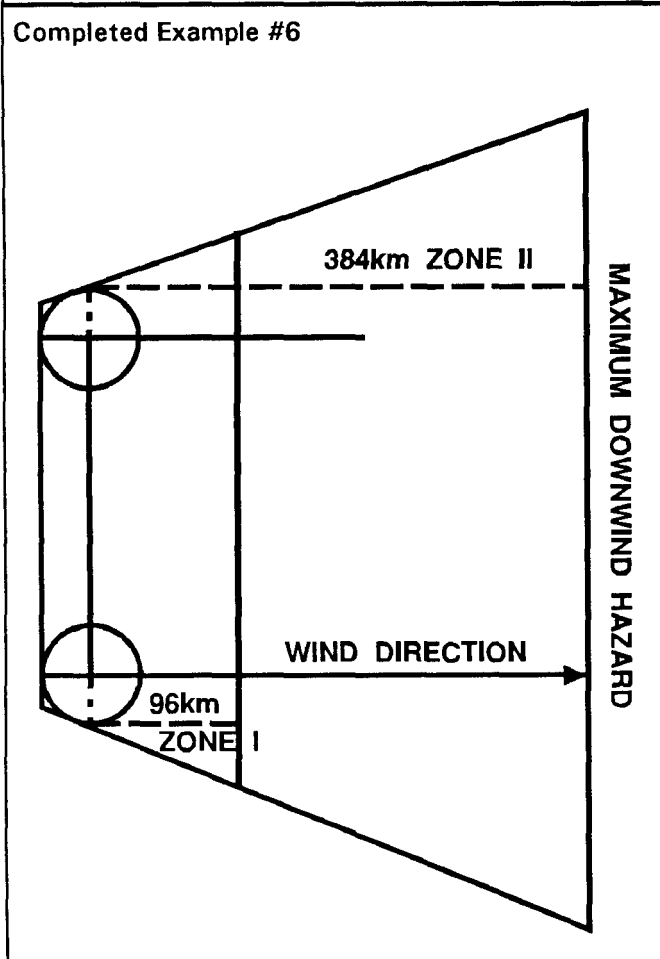
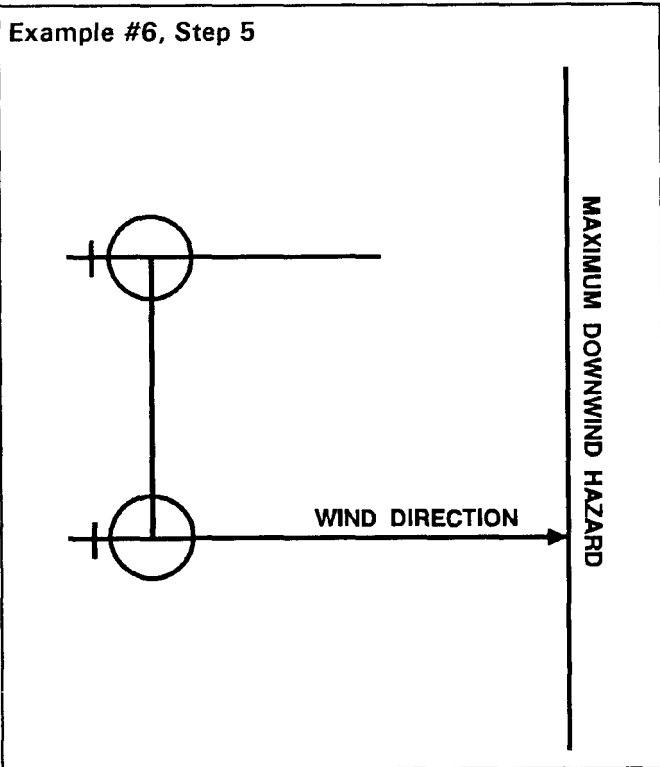

pathological sampling will be initiated only upon the knowledge and consent of the NBCC. Sample priorities are bulk agent and delivery systems, first environmental (contaminated vegetation, soil, water, and clothing), second; and biomedical (patient or autopsy tissue, urine, and sputum) samples, third.

The standard sampling kit is the M34 CBR agent sampling kit. This kit contains material necessary to obtain small liquid and solid samples. Directions for its use are contained in TM 3-6665-268-10. Additional sampling operation guidance is as follows:

- If the M34 kit is not available, a field expedient kit can be assembled from like materials with the help of supporting medical units.
- Hand-off points, sample couriers, special packaging and handling procedures, chain of custody, and diagnostic laboratory delivery points should be coordinated and specified in SOPs/OPLANS. Otherwise, the NBCC will have to coordinate and specify requirements between medical, intelligence, recon, and decon units not previously coordinated (along with any special requirements dictated by the situation).
- Commanders will ensure priority sample transport to diagnostic laboratories.
- Trained medics, intelligence, or chemical personnel should be utilized as sample couriers.
- A strict chain of custody must be maintained. This allows samples to be traced to their origin.
- Sample data must accompany the sample.
- All samples will be in double containers to prevent leakage during transport.

Detailed sampling techniques are further described in FM 3-19, NBC Reconnaissance.

**Evacuation of Biological Samples**

Biological samples must be evacuated to the appropriate laboratory facilities for confirmation of a biological attack. Under normal circumstances labs will be established in the theater of operations to minimize confirmation time. CONUS Labs will also be utilized to verify the results of the theater labs. This information will then be disseminated to subordinate units to ensure that adequate protective measures are implemented for protection of both civilian and military personnel. Confirmation of an enemy biological attack will also be reported to the National Command Authority (NCA) for a decision concerning the appropriate military and diplomatic response. Figure 4-5 shows the standard chain of custody for the evacuation of biological samples.

Biological sampling and detecting on board ships follows the same format as described in this chapter except samples will be sent to the Navy Forward Laboratory for the area concerned.

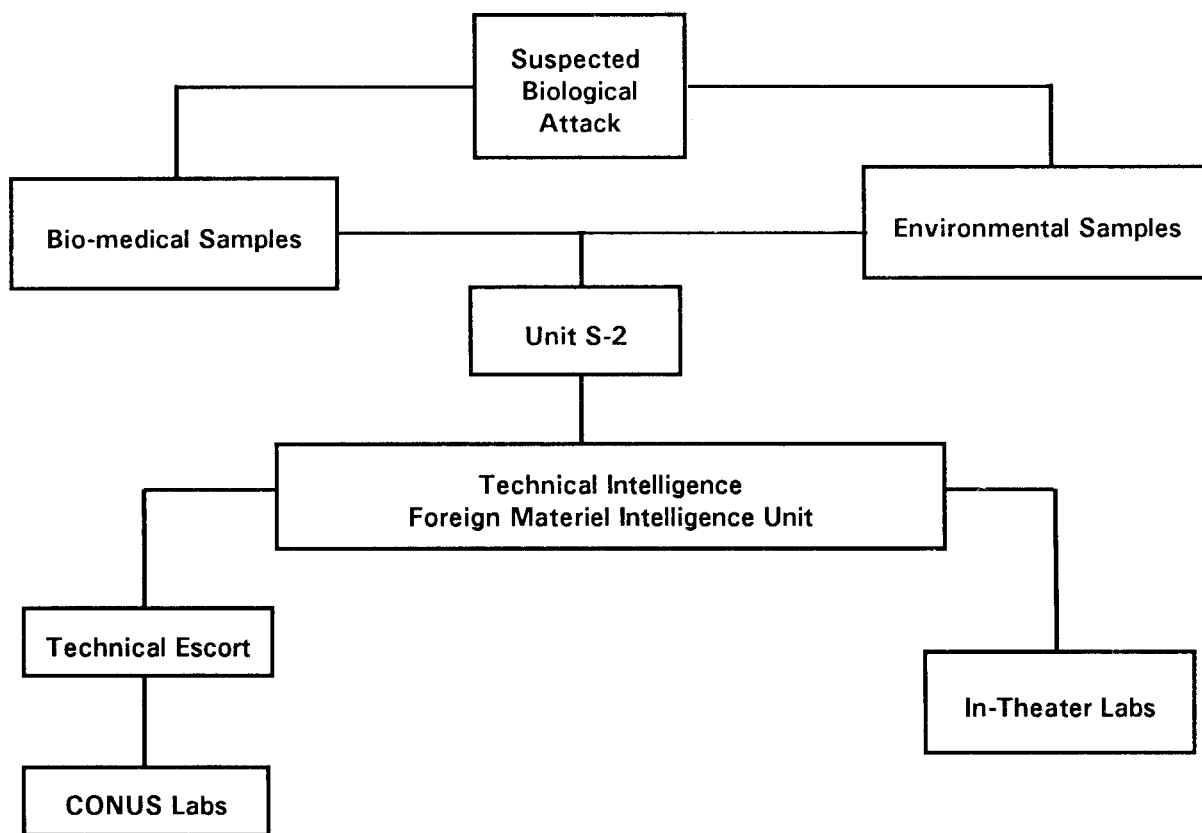

Figure 4-5

# Chapter 5

## CB Reconnaissance, Monitoring, and Survey: Planning, Conducting, Recording, and Reporting

Chemical and Biological (CB) reconnaissance, monitoring, and survey may be divided into two main categories; chemical and biological operations.

### Location of Chemical Agents

Chemical downwind hazard prediction in Chapter 3 provide a means of locating probable chemical hazards. Before units can avoid chemical agents, they must know what type of agent is present and where it is located. Nonpersistent agents are present as a vapor hazard (except in and around the shell crater). Persistent agents are present as both a liquid and vapor hazard. Liquid agents are usually found in the attack area. Vapor hazards are in both the attack and hazard area.

Vapor hazards are the most difficult to predict. They may arise from an agent delivered as a vapor or from evaporation of a liquid chemical agent. The chemical downwind hazard prediction, described in Chapter 3, outlines the largest area vapor could travel. Within that prediction, there are both clean areas and areas where chemical agent vapor still linger. Although computer modeling of the terrain and weather conditions would provide a better picture of where chemical agents may go, it does not preclude sending a soldier to that specific location to verify whether or not the agent in question is there. To accomplish this, units may use the Automatic Chemical Agent Alarm (M8A1), the Chemical Agent Monitor (CAM), and the M256 Samplers/Detectors to locate vapor hazards. FM 3-4 describes in greater detail how weather and terrain affect where chemical agent vapor will exist.

The location of liquid chemical agents is much easier to predict because wind and terrain do not affect their location. It takes significant weather such as a heavy rainfall to move liquid chemical agents. They decompose through weathering; liquid agents usually will evaporate from exposed areas and collect in sheltered areas. Units use ABC MS or M9 Detector Paper to detect liquid hazards. Recon, monitoring, and survey methods are used to locate liquid and vapor hazards.

### Reconnaissance

Recon is searching for chemical hazards in an area before a unit moves into or through the area. All units use reconnaissance to locate chemical hazards. CB recon techniques are similar to conventional recon techniques.

Before moving into or occupying an area, units check the area for enemy activity and the presence of chemical hazards. When in a static position, units recon areas around their positions. The recon team or element may have an Automatic Chemical Agent Alarm, CAM, M256 Series Detector Kit, ABC M8 Paper, M9 Paper, M272 Water Test Kit, and M34 Sampling kit. Division recon elements may also be equipped with the M-93 NBC Reconnaissance Vehicle (FOX).

### Procedures

Recon procedures are the same regardless of who conducts them. The purpose of CB recon is to find the boundary of contamination and/or routes around or through a contaminated area.

Recon teams determine the following information:

- Are there chemical agents present?
- If an agent is present, what type of agent is it?
- Where and when was the agent first detected?
- What are the boundaries of the contaminated area?
- Is there a clean route through the area?

The unit commander then uses this information to form a picture of what chemical agents are in the area of operation. This is used to plan future operations.

Prior to leaving the unit area to conduct the recon, the recon team prepares its equipment and determines areas of priority. Areas of priority include possible movement routes and possible unit locations. The unit commander designates an area for the recon team to return for decontamination.

The recon method used depends on the tactical situation and the need. The following paragraphs describe recon procedures and what decisions must be made. Units adapt these procedures to fit their own need.

The first step is to plan the recon. The unit commander indicates areas of priority and determines approximate distances between recon checks. The

distance depends on the tactical situation, time available, and future use for the area. Distances are less in areas that the unit might move through or occupy. Figure 5-1 shows an example of how priority areas are designated.

Initially the recon team conducts checks at 500-meter intervals. They concentrate on areas where chemical agents will collect: low spots, small valleys, and sheltered locations. For more information on where agents may collect, see FM 3-6.

The recon team uses the CAM and the M256A1 Series Chemical Agent Detection Kits to detect vapors and ABC M8 or M9 Detector Paper to check for liquids. When time is critical, use sampler/detectors only when necessary. If the CAM and M256A1 samplers/detectors are not used, commanders must realize there is a risk of contamination and units must conduct liquid tests as they move through the area.

When the team detects chemical agents, they change procedures. They mark the area (unless ordered otherwise). Then they move back to a clean area.

They then move laterally for a predetermined distance (usually 500 meters), then move forward again. This procedure is followed until they reach the unit boundary or find a clean route through the contamination.

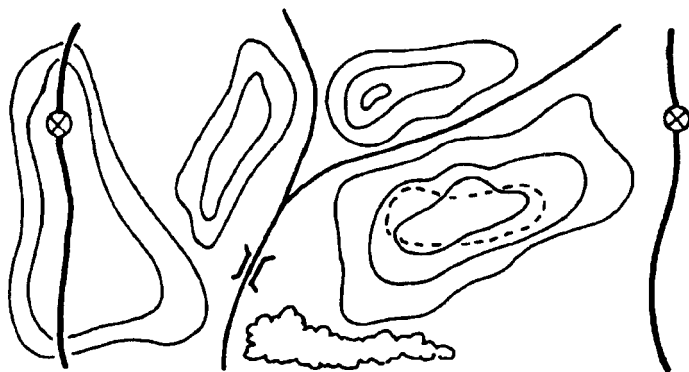

Figure 5-1 Areas of priority for recon operations.

## Recording and Reporting RECON Information

The method the recon team uses to report information depends on how urgently the information is needed. If time is critical, the information is passed over the radio using the NBC 4 Chemical Report format:

### Standard Format

NBC 4 Chemical

H Nerve, V

Q LB195300, Liquid

S 201050Z

If time is not critical, or if radio assets do not permit passing the information over the radio, the information is recorded and carried back to the unit. The chemical data sheet is used to record and transfer recon information. Figure 5-2 shows a completed DA Form 1971-2-R (Chemical Data Sheet-Monitoring or Survey).

## Monitoring

All units use monitoring to determine if a hazard is still present. Monitoring can be done on personnel, equipment, or terrain. Basically it is a recheck to see if a contamination hazard, identified by a recon team or in detecting an attack, still exists. The purpose of monitoring is to enable the commander to decide the protective posture of the unit. If monitoring reveals no hazard, then the units may lower their MOPP level (depending on the threat workload). The M256A1 Detector Kit is the primary piece of equipment used to monitor for chemical agents. This kit, supplemented by the CAM, M8A1 Alarm, and ABC M8/M9 Detector Paper provide the monitor with the necessary equipment to detect the presence of chemical agents. If monitoring reveals that the chemical agent is still present on equipment, decon operations may be required.

## Surveys

Chemical surveys are required when the commander needs detailed information on the size of a contaminated area. Unlike radiological surveys, the intensity of chemical contamination cannot be determined. Learning the extent of contamination within the area of interest and along specific routes is the primary interest.

Recon elements find the contaminated areas. The unit conducting the chemical survey usually knows the general location of the contamination and what type agent to expect. It may also know how the agent was delivered. This helps when planning the survey.

For example, an area contaminated by an artillery attack usually is smaller than an area contaminated by a spray attack. This information determines the number of recon teams needed and the amount of time needed to conduct the chemical survey.

Time is a major factor in planning and conducting chemical surveys. Each detection test requires time. The primary concern in surveys is to determine areas contaminated by persistent chemical agents, so the majority of the testing done during a survey is with M8 or M9 Detector Paper. Periodic tests are done with the M256A1 Detection Kit to ensure that only the chemical agent being tested for with the detection paper is present.

CHEMICAL DATA SHEET - MONITORING OR SURVEY		DATE	PAGE NO.	NO. OF PAGES
For use of this form, see FM 3-3. Proponent of this form is USACMLS		14 July 86	1	1
UNIT B Co 2/31 Inf	MONITOR OR SURVEY TEAM MEMBER (Print Name)			
MONITOR OR SURVEY TEAM NUMBER #82	SP/4 Mayer			
MAP USED Karlsbad	TYPE DETECTOR USED			AGENT DETECTFD
LOCATION/TIME OF TEST OR INDICATION	PAPER	ALARM	KIT	
WV521678/1006003		✓		NERVE
WV521676/1006253	✓			v.
WV521674/1006363	✓			v.
WV521672/1006473	✓			v.
WV521670/1007153	✓			v.
SAMPLE				
REMARKS				

DA FORM 1971-2-R  
JUNE 86

Figure 5-2. Completed DA Form 1971-2-R for Monitoring.

When conducting a chemical survey, there are several possibilities that must be considered: what type agent is known to be present, is there a chance for a mixture of agents, and how much time is available to do the survey. The most important aspect is to do a thorough job. If a hazard is missed, the unit could sustain casualties when they occupy the area. Figure 5-3 gives an indication of how long surveys take.

The size of a contaminated area is important, in determining the number of teams needed to conduct the survey. Use the following table to estimate the size of the attack area for planning purposes.

Attack area radii for different type munitions.	
Type Munition	Attack Area (radius)
Artillery, bombers, and mortars.	≤ 1 km
Missiles, bombs, unknown munitions, and multiple rocket launchers.	> 1 km to < 2 km
Aircraft spray or rocket spray	> 2 km
Example: 1/4 - kilometer target radius Use M256/M256A1 kit for initial test only 16 minutes Use detector paper for five minutes at four locations 20 minutes Walking a total of approximately 2,500 meters 60 minutes Total time for a four - man team 96 minutes	

Figure 5-3. Time required for 1/4 - kilometer radius chemical survey (four man team).

## Techniques

Three techniques are used to conduct chemical surveys. They are route, point and area surveys. Routes and specific points may be surveyed if that information is needed. If conducted, the survey team goes to a specific point or points along a route and test for the presence of liquid contamination with ABC M8 or M9 Detector Paper.

The area survey is used to determine how large an area is contaminated. This information is used to determine whether to bypass or cross through the contaminated area. Area surveys can also be used to find relatively clean areas or clean routes within a contaminated area.

Figure 5-5 shows the basic concept used for conducting an area survey. In this illustration, the attack has a 1-kilometer target radius. The basic procedure applies to any target radius.

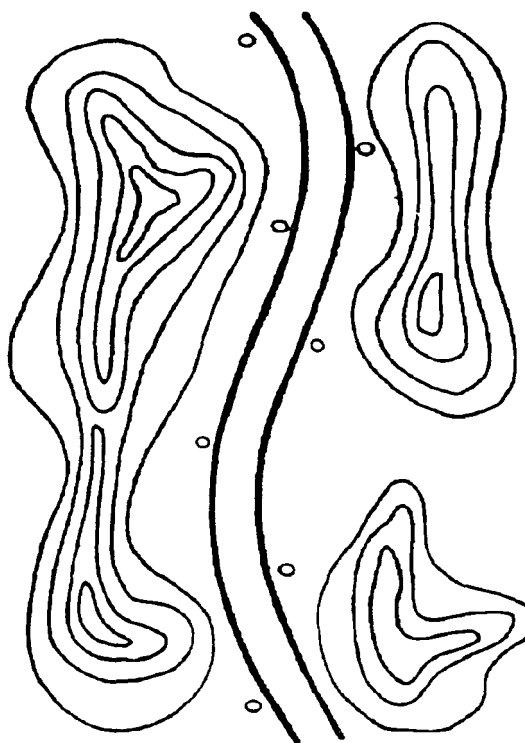

Figure 5-4. Route chemical survey.

If the agent identified by the detector kit is also detectable with ABC M8 or M9 Paper, perform all subsequent tests with detector paper. This will reduce the time required to perform the area survey.

The NBCC provides each survey team with an overlay showing the area to be surveyed. It also shows the initial test points for each survey team. Figure 5-5 shows the initial and subsequent test points for one survey team. The Figure also shows how teams 1 through 4 are equally spread out so that the chemical survey teams cover one fourth of the survey area. Each team tests with the detector kit at the initial testing point. Detector paper tests are taken every 200 meters until the agent reacts with the paper or until each team member comes to within 200 meters of the attack center. All team members will exit the area by the route used by the vehicle operator.

If only one survey team is used, the survey team repeats the above procedures for each sector. If more than one team is used, the NBCC identifies each team's starting points (SP).



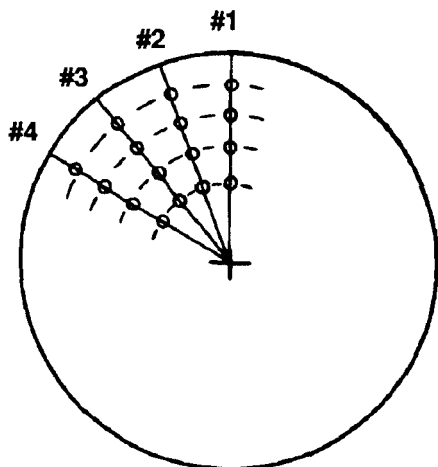

○ TEST LOCATION

Figure 5-5. Area chemical survey.

## Recording and Reporting Procedures

Record results of a chemical survey on a DA 1971-2-R Chemical Survey Data Form. The important information is the type of agent, the location where it was detected, and the type of test taken. Figure 5-2 shows a completed Chemical Survey Form.

The method used to report the chemical survey results depends on the situation. Since chemical survey reports are lengthy, the information usually is not transmitted back to the NBCC. The completed data sheet is carried back and handed to the NBCC. If time is essential, the information can be sent over the radio net. If this is done, the information is transmitted in an NBC 4 Chemical Report format.

## Operational Aspects

Recon locates contaminated areas, monitoring finds contamination on personnel and equipment, and surveys confirm and define contaminated areas. These areas must be marked as contaminated. Use the NBC Contamination Marking Set described on page 5-9. Once located, the coordinates of the contamination areas are plotted as an overlay on the situation map. Units use this contamination overlay to plan operations. Commanders determine routes and unit positions, and plan tactical operations based on where the contamination is located. If unable to avoid the area, commanders determine routes of least contamination and determine what protection is required. They also choose locations for individual and unit decon sites on the other side of the contamination area.

Information on where NBC contamination is located is passed from one unit to another using the NBC 5

Chemical Report. It usually is sent as an overlay. Figure 5-6 shows an NBC 5 overlay with required marginal information. If time and distance do not permit, it can be sent as a NBC 5 Chemical Report. Figure 5-7 is an example of an NBC 5 Chemical Report.

56 |  
| 40

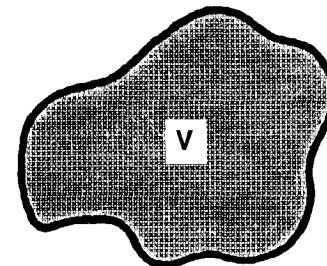

HQ 1st Inf Bde  
A C2001  
D 200945Z  
H Nerve, V  
S 201111Z  
T 201210Z  
Prepared 201138Z

77 |  
| 22

Figure 5-6. NBC 5 Chemical Overlay.

STANDARD FORMAT	USMTF PROGRAM
A C2001	NBC5
D 200945Z	MSGID/NBC5//
H Nerve, P, Air	NBCEVENT/CHEMICAL//
S 201111Z	ALPHA/2001//
T 201210Z	DELTA/200945Z//
X LB197306	HOTEL/NERVE, P/AIR//
LB19229Z	SIERRA/201111Z//
LB200310	TANGO/201210Z//
LB205303	XRAY/LB197306/LB19229Z/
LB205303	LB200310/LB205303/
LB207293	LB207293/LB207298/
LB207298	LB195300/LB197306//
LB195300	
LB197306	

Figure 5-7. Sample NBC 5 Chemical Report.

Note: The coordinates in line Xray must be sent and plotted sequentially. If line XRAY's beginning and ending grid coordinates do not match, this means you have an open area of contamination.

Another method used to pass information about a chemical attack is the NBC 6 Chemical Report. It is especially useful for a unit just arriving in an area of operation because it gives a summary of the chemical activity in that area. Figure 5-8 is an example of an NBC 6 Chemical Report.

STANDARD FORMAT	USMTF FORMAT
<b>IMMEDIATE</b>	<b>NBC 6</b>
<b>NBC 6 Chemical Report</b>	<b>MSGID/ NBC6//</b>
<b>A C2001</b>	<b>NBCEVENT/ CHEMICAL//</b>
<b>D 200945Z</b>	<b>ALPHA/ C2001//</b>
<b>E 200950Z</b>	<b>DELTA/ 200945Z//</b>
<b>F LB200300, Actual</b>	<b>ECHO BC/ 200950Z//</b>
<b>G Artillery</b>	<b>FOXTROT/ A/15RLB200300//</b>
<b>H Nerve, Airburst</b>	<b>GOLF/ Artillery//</b>
<b>I 20 Rounds</b>	<b>HOTEL BC/ Nerve, V/Air//</b>
<b>K Mostly small houses and barns, elevation 600 meters</b>	<b>INDIA/ 20 rounds</b>
<b>M Attack received as counterfire, enemy bypassed on right flank of attack area</b>	<b>KILO BC/ Farmlands/elev 600//</b>
<b>Q Liquid ground sample taken by detection team in attack area</b>	<b>MIKE SIX/ Attack received as counterfire, enemy bypassed on right flank//</b>
<b>S 201005Z</b>	<b>QUEBEC BC/ LB200300/Liquid tested with M9 paper//</b>
<b>T 201110Z</b>	<b>SIERRA/ 201005Z//</b>
<b>X LB195300</b>	<b>TANGO BC/ 201110Z//</b>
<b>LB 197306</b>	<b>XRAY/ LB206302/</b>
<b>LB198292</b>	<b>LB209298/</b>
<b>LB200310</b>	<b>LB199301/</b>
<b>LB205303</b>	<b>LB199299/</b>
<b>LB207293</b>	<b>YANKEE BC/ 0090 DEG</b>
<b>LB207928</b>	<b>ZULU B/ Grid/010KMH//</b>
<b>LB195300</b>	<b>Only attack in our area//</b>
<b>Y Downwind direction 0090 degrees, wind speed 010 kmph</b>	
<b>Z This is the only chemical attack in our area to date</b>	

Figure 5-8. Sample NBC 6 Chemical Report

## Point Surveillance, Area Surveillance, and Reconnaissance

The following chemical surveillance measures and reconnaissance techniques may be recommended by the staff chemical officer to support the scheme of maneuver:

### Point Surveillance

The point surveillance mission is conducted for a specific period of time, oriented to key terrain. It is typically conducted to ensure that time sensitive or critical operations can be conducted without unwarned encounters with chemical agent clouds or transfer hazards resulting from a munitions event. For example, use an M8A1 alarm or an XM21 on a ridgeline oriented upon a bridge or on a other identifiable choke point up or down a valley. The principle advantage of this employment technique is that it capitalizes upon the strengths and minimizes the weak points of the detector. The XM21 is best used where a heavy agent vapor concentration of short-to-medium size will be seen within the entire field of view of the detector.

### Area Surveillance

The goal of the area surveillance mission is to provide

a tailored detection capability in those tactical situations where it is impractical to employ remoted point samplers, such as the M8A1 system. This would be done when the need for operational security, emplacement/recovery time/workload requirements, and some operational risk is acceptable. The mission may be conducted while mounted in the M93 Reconnaissance Vehicle or dismounted (using the XM21 Remote Alarm, M8A1 Alarm, and the M256A1 kit) configuration based upon the situation and the support unit.

### Reconnaissance (NBCRS Mounted)

The reconnaissance mission is conducted to reduce the time required to perform NBCRS primary mission or to increase confidence that an area is uncontaminated. In a typical mission supporting NBC reconnaissance, an additional team may be used to monitor a portion of a route, that has been previously checked and classified as uncontaminated by the NBCRS. While the NBCRS is checking an adjacent route, a task organized team equipped with an M8A1 Alarm, XM21 Alarm, CAM or ICAD may overwatch the

area just checked to report if a munitions event occurs following recon and prior to use of the route by the maneuver force.

### Division NBC Center

At the Division, brigade mission support request are received by the NBCC and compared with division requirements to ensure that there is no redundancy. These request for support are weighted against the Division Commander's concept of the operation and a priority is assigned. The Division Chemical Officer then provides a proposed course of action to the G3 designed to accomplish hazard avoidance for the division.

### Mission Management

Mission management is the direction and control of hazard avoidance operations. It involves identifying and planning necessary actions for satisfying each identified requirement. Mission management at the division level is accomplished by the NBCC. This section prepares the division hazard avoidance plan and coordinates it with the division reconnaissance and surveillance plan that is developed by the G2.

### Contamination Marking

Once contamination is found, mark the area and-report to higher headquarters. Marking contaminated areas and equipment warns friendly units and helps them avoid the contamination. Marking a contaminated area merely indicates the presence of a hazard. The extent of a

hazard is determined by a detailed survey.

### Standard Signs

Signs used for marking contaminated areas are standard throughout NATO in color and size. This permits easy identification. The color of the sign indicates the type of contamination. The primary or background color indicates the general type of hazard. The secondary color gives specifics as to what the hazard is. Figure 5-9 (page 5-8) describes the various signs, their colors, and required data.

In addition to color, signs are also a standard size and shape. The sign is a right-angled isosceles triangle. The base is approximately 28 centimeters (11-1/2 inches) and the sides are approximately 20 centimeters (8 inches). The signs can be made of wood, plastic, metal, or any other available material. Place the signs with the point of the triangle facing down.

For biological contamination and for persistent or semipersistent chemical agents, you need the type of agent (if known), date and time of detection.

The United States marks contaminated areas with the NBC Contamination Marking Set. It contains everything needed to mark a contaminated area - flags, ribbon, crayons, mounting stakes, and a carrying container. TM 3-9905-001-10 describes the kit and its use. Figure 5-10 (page 5-9) shows the kit and its major components.

If units do not have this kit available, they can make the signs out of available metal, plastic, or wood. These field expedient signs must be of standard shapes, sizes, and colors.

### Marking Procedures

Marking warns friendly troops of contamination. Therefore, the signs are placed where they most likely will be encountered by friendly units. In rear areas the entire circumference of the hazard area may need to be marked. Individuals who find the contamination place the signs. They are placed where the contamination is detected. Adjacent signs should be within sight of each other (25 to 100 meters apart depending on terrain). This prevents units from missing the signs and entering a contaminated area. Recon elements mark the area at the point of entry. Unit survey teams are then responsible for determining and marking the extent of the contamination.

Some areas may contain more than one type of contamination or hazard. Mark these areas with the appropriate signs placed near each other. For example, if an area is both chemically and biologically contaminated, both signs are used and placed near each other.

For rear areas, in, around, and behind the Division Support Area (DSA), and while in open terrain (i.e., desert, plains, rolling hills . . . etc) it is possible to raise

these contamination markers on poles. These poles may be camouflage support poles, extra tent poles or any other such material. The intent is to raise the contamination marker up high enough so that it can be seen for at least 200 meters. This is done so that follow-on forces and support troops can be aware of the hazard.

In these rear areas, "clear areas" or "lanes" may also be marked for easy identification. One method of marking this lane is using the CB Contamination Bypass Marker depicted in Figure 5-11 and 5-12 (page 5-10).

*NOTE: Placing markers on poles, or using the bypass marker in forward areas is considered tactically unsound and should be avoided. It would only provide a roadmap for the enemy.*

### Marking Contaminated Materiel

Special procedures are used when marking and handling contaminated materiel. Materiel is marked to keep personnel from accidentally becoming contaminated. This means that markers placed on materiel have to be visible from any angle. The disposition of the materiel depends on the situation. If it can be left in place to weather, that might be the best solution. If contaminated materiel is collected in a holding area, then the area has to be marked and monitored for residual hazards. Since vapor hazards are additive, several pieces of like contaminated equipment together could create a serious vapor hazard when located near each other. This could be a problem in areas such as maintenance holding areas.

Since residual hazards can collect in inaccessible places, contaminated vehicles and equipment must be marked or identified. Otherwise, maintenance personnel could be injured by hidden contamination. One way of doing this is to attach a marker to the outside of the vehicle.

### Biological Sampling

Since the type and amount of a Biological Warfare (BW) agent cannot be determined in the field, properly collected samples, along with accurate background information, is critical for the evaluation of a suspected use of BW agents. A properly collected sample can aid in:

- identifying the agent/confirming that an attack has occurred
- determining the proper therapy for exposed personnel
- estimating the possible number and type of casualties
- determining the time-to-casualties if time of the attack is known
- evaluating an enemy's BW capability

The reliability of evidence that BW agent(s) have been

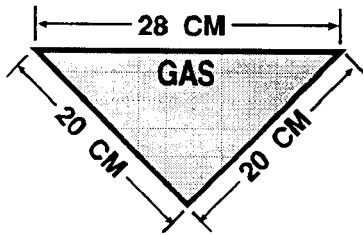

**CHEMICAL**  
**Yellow Background**  
**With Red Lettering**

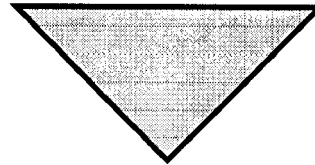

**Name of Agent (If Known)**  
**Date and Time of Detection**

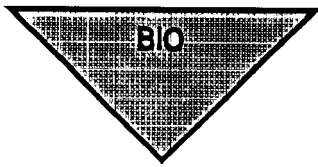

**BIOLOGICAL**  
**Blue Background**  
**With Red Lettering**

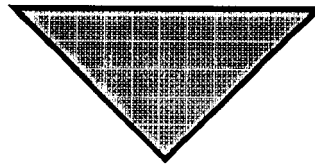

**Name of Agent (If Known)**  
**Date and Time of Detection**

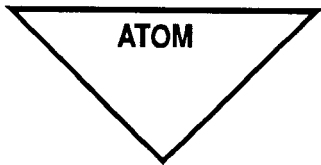

**RADIOLOGICAL**  
**White Background**  
**With Black Lettering**

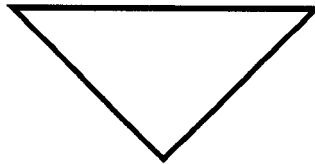

**Dose Rate**  
**Date and Time of Reading**  
**Date and Time of Burst**  
**(If Known)**

**Surface of Marker Facing**  
**Away From Contamination**  
**(Front)**

**Surface of Marker Facing**  
**Contamination (Back)**



**CHEMICAL MINEFIELD**  
**(UNEXPLODED MINES)**

**Red Background**  
**With Yellow Lettering**  
**and Stripe**

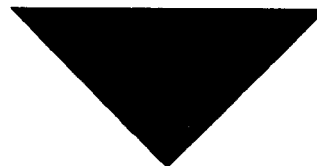

**Chemical Agent in Mine**  
**Date of Emplacement**

**Surface of Marker Facing**  
**Away From Minefield (Front)**

**Surface of Marker Facing**  
**Minefield (Back)**

*Figure 5-9. NBC Contamination Marking Signs.*

**FLAG CONTAINERS**

Each container holds 20 marking flags:

20 white flags for marking nuclear contamination.

20 blue flags for marking biological contamination.

20 yellow flags for marking chemical contamination.

**RIBBON CONTAINER**

Holds 13 separate rolls of yellow-marking ribbon.

Ribbon used to provide a way to hang flags between poles or other objects.

Carrying straps can be adjusted for front or back wear.

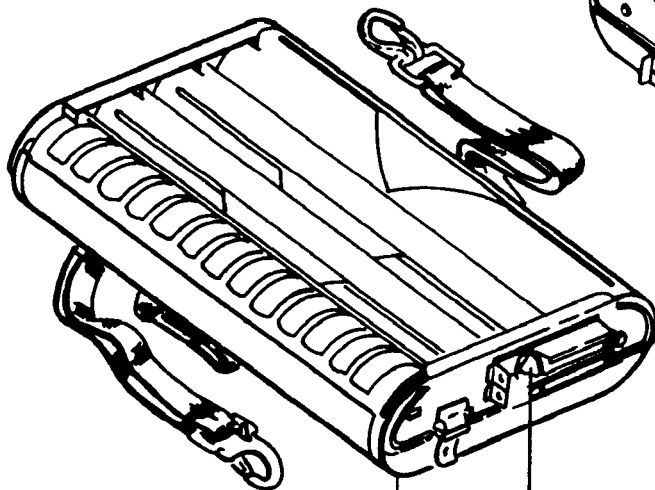

**CARRYING CONTAINER**

Holds all individual parts of set.

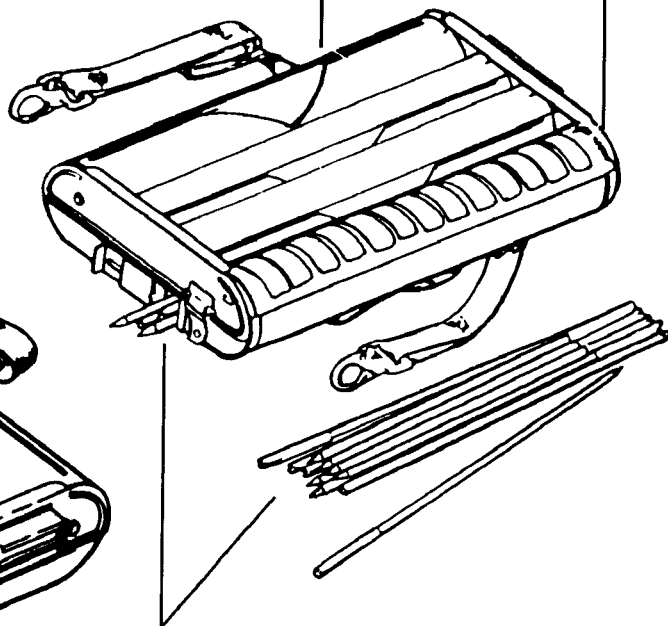

**MOUNTING STAKES**

48 stakes stored in bottom of carrying container.

Used to make poles for hanging flags and attaching marking ribbon.

**CRAYONS**

Red crayons used to mark information on flags.

Figure 5-10. NBC Contamination Marking Set.

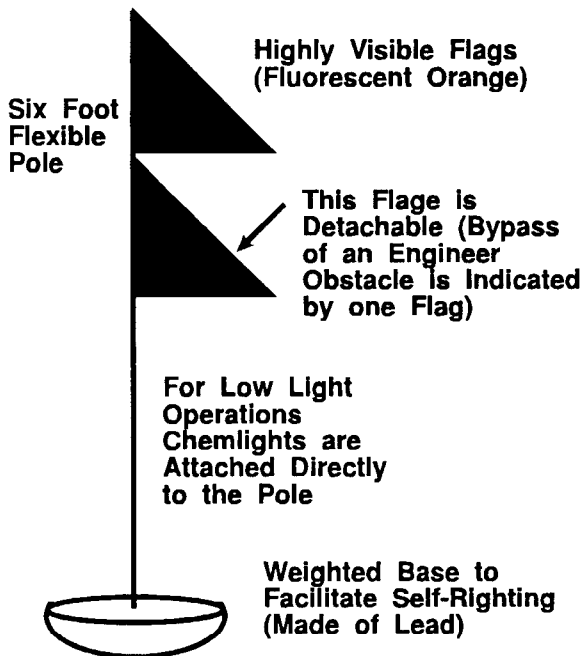

**BASIS OF ISSUE:**

- 6/Infantry, Scout, and Engineer Platoon
- 6/NBC Recon Vehicle
- 6/Smoke Generator and Decon Squad

*Figure 5-11. Contamination Bypass Marker.*

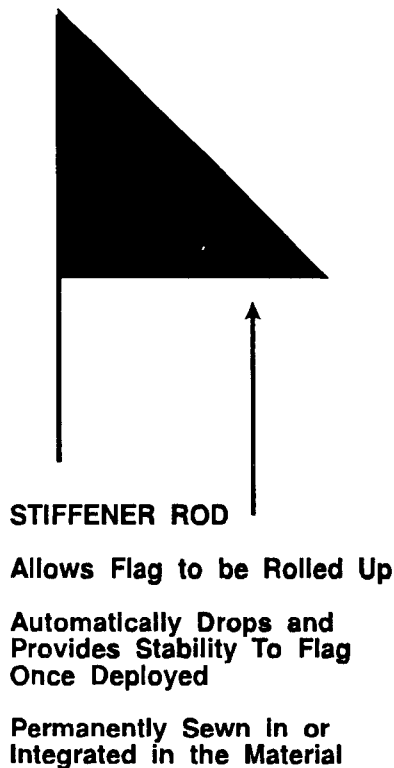

*Figure 5-12. Contamination Bypass Marker.*

used is extremely important. Therefore, the collection of samples and background information must be as detailed and comprehensive as possible. Information presented by witnesses must be screened to ensure that hearsay is not substituted for accurate reporting.

Sampling is done by trained personnel. These are usually chemical and/or NBC recon personnel. They may be assisted/advised by intelligence or medical personnel; such assistance should be incorporated into SOPs and OPLANs. Trained personnel ensure uniformity, viability, safety, and accountability in sampling procedures. Sampling is not done indiscriminately, but only when an attack has occurred. Sampling operations will be initiated only upon the knowledge and consent of the NBCC. Sample priorities are bulk agent and delivery systems, first; environmental (contaminated vegetation, soil, water, and clothing), second; and biomedical (patient or autopsy tissue, urine, and sputum) samples, third. Biomedical samples should be taken only by trained medical personnel. If trained medical personnel are not available it may be necessary to retrieve the entire remains for evaluation.

The standard sampling kit is the M34 CBR Agent Sampling Kit or the Chemical-Biological Agent Sampling Kit (CBASK). These kits contain material necessary to obtain small liquid and solid samples. Directions for use are contained in TM 3-6665-268-10.

Additional sampling operation guidance is as follows:

- If the M34 kit is not available, a field expedient kit can be assembled from like materials with the help of supporting medical units. A list of suggested materials is presented in Table 5-1 (page 5-12).
  - Hand-off points (most appropriately the decon point for the recon mission team), sample couriers, special packaging and handling procedures, chain of custody, and diagnostic laboratory delivery points should be coordinated and specified in SOPs/OPLANs. Otherwise, the NBCC will have to coordinate and specify requirements between medical, intelligence, recon, and decon units not previously coordinated (along with any special requirements dictated by the situation).
  - Commanders will ensure priority sample transport to diagnostic laboratories.
  - Trained medics, intelligence, or chemical personnel should be utilized as sample couriers.
  - A strict chain of custody must be maintained. This allows samples to be traced to their origin.
  - Sample data must accompany the sample.
  - All samples will be in double containers to prevent leakage during transport.
- Detailed sampling techniques are further described in

FM 3-19 NBC Reconnaissance.

The following provides general guidance for BW sampling.

## Types of Samples

### Liquids.

Droplets on vegetation.

Dark stained spots on ground.

Preferred sample - e.g., container of liquid (from storage).

stagnant pools - oily globules/suspended solids.

Streams where dead animals/fish are seen.

Pools of water, ponds, streams, or reservoirs, can be an important source of samples. These samples should be kept in a cold state to enhance preservation of the suspect agent contamination.

### Vegetation

Discolored

Withered

Oily droplets

Other unnatural particulates

Vegetation, whether grass, bushes, grain or other growth is a definite medium for sample absorption/adsorption. Quantities of the order of a kilogram or more should be collected in bags made of polyethylene or other relatively impermeable material.

### Soil

Discolored

Oily looking spots

Soil, sand or rock in the direct vicinity of dissemination or at least downwind of the event is an important source of agent sample. The sand or soil sample need not be taken beyond 4 cm in depth but preferably more than 100 cm in an area. Include plants, seeds, and debris when present. Even larger samples should be taken if logistically feasible. Glass bottles or jars where feasible, should be used to hold the sample rather than plastic bags, to preclude the possible contamination of the soil sample by the plasticizers from the bag. Samples should then be marked for identification and returned to the laboratory.

### Ordnance

Munitions or fragments, whether originally from shell, bomb, rocket, grenade, spent aircraft spray tanks or other field dispersal system can be highly definitive sources of samples. Whole munitions or "duds" are a highly desirable source of sample, but should be handled (disarmed) only by explosive ordnance specialist. Small contaminated objects should be placed in kettles, sealed and forwarded to the laboratory for analysis.

Small animals either dead or dying, especially where a toxic event is indicated, should be collected as a possible source of sample.

Permanent structures such as buildings, walls, paved surfaces or field vehicles are sources of impacted adsorbed/absorbed sample. These can be sampled by scraping, swabbing or even washing (with collection of the wash) and transported in bottles or tubes. Precautions should be taken to avoid unnecessary debris in the extraction fluid.

### Priorities

Sampling Priorities.

Samples should be collected that provide objective indications of a biological attack. Sample collection should be planned and executed in accordance with the following general scale of relevance:

- **First priority.** Biological agents or munitions (including residues or fragments, NBC protective equipment, in particular used respirator canisters and clothing.

- **Second priority.** Typical samples from the environment (vegetation, earth, stones, water, etc.) in the vicinity of the alleged attack or incident.

- **Third priority.** (Collected by medical personnel only). Biomedical samples, either from presumed casualties (samples of blood, urine, etc.) or from human and/or animal corpses.

General Precautions.

Many samples as well as the sampling site may be inherently dangerous. Appropriate individual protection measures must be taken and specific precautions observed in collecting, handling, storing and transporting samples. This is not only to safeguard those individuals handling the samples, but also to preserve the sample itself.

Technical advice and assistance. If munitions are to be handled or are in the area of the sampling site, specific assistance and technical and ordnance advice should be obtained. On-site medical assistance should also be obtained.

### Quantities

Liquids - 1 teflon bottle 180 ML or 6 oz desired.

Vegetation - up to a kilogram or more of vegetation should be collected when possible.

Soil. 10 cm x 10 cm and a depth not to exceed 4 cm include plant, seeds and debris when present.

Ordnance: Whole munition intact, no leaks if possible, commonly referred to as duds. Call ordnance disposal units before moving.

Used personal protective and CB warfare equipment.

Package each item separately.

Biomedical - Samples from dead animals. If the organism is small, collect and ship the entire carcass. Efforts should be made to collect the most common species in the area for example, rats from local dwellings, fish or common small birds.

Non-Transportable Items: Samples should then be taken by scraping or rubbing the contaminated surface with dry cotton wool or cotton wool soaked in distilled water. The scrapings and the cotton wool pads shall be carefully preserved in airtight Teflon containers.

### Sampling Equipment

Various methods may be used to collect suspected biological samples. For air samples, the XM2 Biological Sampler provides an effective means of identifying biological agents. Commercial air samplers can also be used concentrate air samples for later identification. However, the most common sampling tool is the modular Chemical and Biological Agent Sampling Kit (CBASK). If this kit is not available, a number of items available through supply channels or commercial sources can be used. A listing of common materials available is presented in Table 5-1.

The XM2 Biological Agent Sampler is a manually operated device that is capable of providing identification of specific biological agents after an attack, when used in conjunction with an enzyme-linked immunosorbent assay (ELISA) test kit. The ELISA tests are agent specific and consist of a cotton swab and a test ticket. Once the air sample is obtained, the cotton swab is placed in the collection vial to absorb a small amount of substance. The swab is then placed in a test ticket for a reading (see Figure 5-13). Depending upon the urgency and the degree of validity required for the identification, the operator will draw one or two samples. Each sample will take approximately 45 minutes for testing with the ELISA test. The sampler, itself is powered by a 120V AC ± 10 percent 60 Hz, 300 watt power source (see Figure 5-14).

The sampler draws 1000 liters of air per minute and separates the particles from the air, 2 to 10 microns in diameter. It then condenses these particulates into a 15 liter per minute stream of air directed into the wet collector, where the particles become suspended in liquid.

The remaining 985 liters is transferred to the cooling drawer and control module. Due to the large volume of air drawn in, additional filters may be necessary to filter out dust, sand and dirt particles (NOTE: silt sand average particle size is approximately 62 microns in diameter). This sampler, when in the transit case weighs 240 pounds. (Therefore, because of its size and power requirements, the XM2 cannot be used for

Table 5-1. Current Sampling/Packaging Equipment

Description	
labels, paper, pressure sensitive	7530-00-577-4376
Edmont Wilson gloves 8-8	8415-00-J02-2902
Edmont Wilson gloves 9-9	8415-00-634-4639
tape, pressure sensitive adhesive 1"	7510-00-582-4772
pliers #47 5"	6520-00-543-5350
screwdriver, flat tip 1/4 inch	5120-00-596-8653
tongs, teflon tips	AF 15-202-5
micro spatula with teflon ends	AF 21-401-50A
scissors, universal type	AF 08-951-30
sterile sampler scoops 2 oz	AF 14-241-10A
spoon spatula with teflon	AF 14-356-10
knife, pocket	5110-00-526-8740
PFA sample bottles, 6 oz	CP J-6103-50
pipet, jumbo transfer type	AF 13-711-7
pipet, graduated transfer type	AF 13-711-9A
insulated bag, type 1	AF 01-814-8
insulated bag, type 2	AF 01-814-10
whirl/pak bag, 6 oz	AF 01-812-6B
ph paper, non-bleeding plastic strip	SW S-65271
SEP-PAK C18	
syringe, hyp 50 or 60 ml	6515-00-168-6913
R3602 clear laboratory tubing	AF 14-169-3B
marking pen, waterproof	AF 13-381
Tenax tubes	EC ST-023
blade surgical knife detach no. 21	6515-00-660-0007
blade surg cs 21 150S	6515-01-009-5297
igloo type container	
ice pack	CP TR-6345-20
pad non-adherent 3 x 4 100s	6510-00-111-0708
pad cooling chemical 4S	6530-00-133-4299
piglette	
tape, antiseizing	8030-00-889-3535
personal air sampler	LSS G4980 +
methanol	GJ4981
distilled water	
matches, waterproof	
Mylar bags	
Field Expedient Packing Materials	
Tin foil	
Saran wrap * polyethylene without plasticizers	
Thermos bottles	
Pressure sensitive tape	
Cool Paks	
Butcher Paper	
newspaper	
igloo cooler	
Canteens	
Mess kits	
Glass bottles	
packing material	
Teflon plumbers tape	
Medical supplies	

reconnaissance purposed). Although, with some difficulty, a vehicle could move the XM2 from one pre-planned sampling point to another.

### Commercial Air Samplers

Many different styles and types of commercial samplers exist. These samplers are used by industry to monitor for air pollution and airborne hazards compounds. Each sampler has its own unique characteristics and should be employed in the same manner as the XM2.

When handling the sample respiratory protection desired. DO NOT handle the sample. If the sample has



IF THE COLOR IS...		THEN THE REACTION IS...
Not Visible	○	Absent
Very Faint Pink	◐	Weak
Distinct and Uniformly Pink	●	Moderate
Very Distinct and Dark Red to Purple	●	Strong

Reactions may appear in any shape (i.e., rings, crescents, dots) and should be interpreted for color intensity only. Any colored shape in the test spot of greater intensity than the negative control spot, should be interpreted as a positive result.

Figure 5-13. Elisa Test Spots

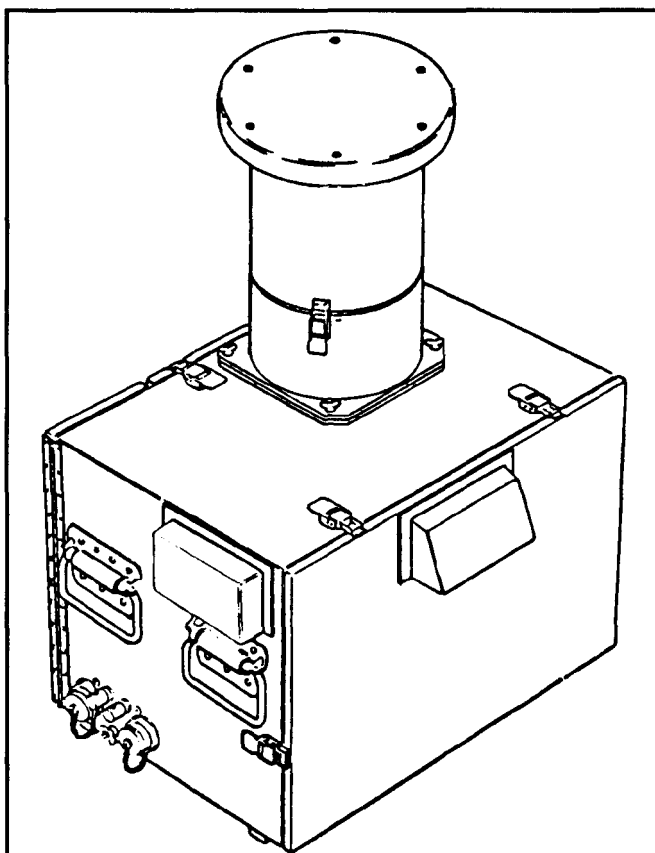

Figure 5-14. XM2 Sampler.

to be handled neoprene gloves should be used.

Have the individual who has control of the sample, place the sample in mylar bag or substitute (i.e., tin foil, saran wrap.)

\* NOTE: If sample is in a glass container with a lid seal lid with pressure sensitive tape and triple wrap the container first with tinfoil then saran wrap.

### Employment

Employment considerations are more dependent on the cloud parameters, climate and method of dissemination than anything else, until agent specific cloud parameters are made available. The XM2 will be employed at preplanned point sampling sites within theater or area of operations. These sites will be designated by the theater or operational commander and are to be associated with high probability targets. These targets may be large urban areas, politically sensitive areas, logistical centers, port facilities, airfields, large command and control centers . . . etc. Due to the characteristics of BW agents, until a sample is obtained, the collector operators do not know if the agent is chemical or biological in origin. The correct placement of an air sampler is depicted in Figure 5-15a.

### Modular Chemical and Biological Agent Sampling Kit (CBASK).

The equipment in this kit can be used to bring back samples of solids, liquids, and gases. Three colors are used to tell you which piece of equipment can best be used for sampling solids, liquids, or gases. These are:

**GASES.** Use equipment such as the air pump and adsorption tubes. (YELLOW)

**LIQUIDS.** Water cartridges, pipettes, and syringes will be used to take samples from water or directly from chemical liquids. (RED)

**SOLIDS.** Scoops, spatulas, knives, and bags will be used to take solid samples such as dirt or chemical powders. (BLUE)

The kit contains four packs, three of which are in nylon bags. Use these packs for solid and liquid sampling. The other pack cannot be removed from the kit. This pack contains equipment for taking gas samples. It also contains a small cooling box to hold things which might rot or disintegrate. Colored circles on certain equipment will help you identify its use. For instance, yellow is for gas sampling.

### Safety

Each kit comes with two pairs of butyl rubber gloves. These gloves should be used at all times when you are sampling for possible agents. Further, wear the protective mask when safety conditions are unknown (which is most of the time).

### Where to Take Samples

The officer or NCO in charge will tell you where to take samples and the types needed. Generally, you will

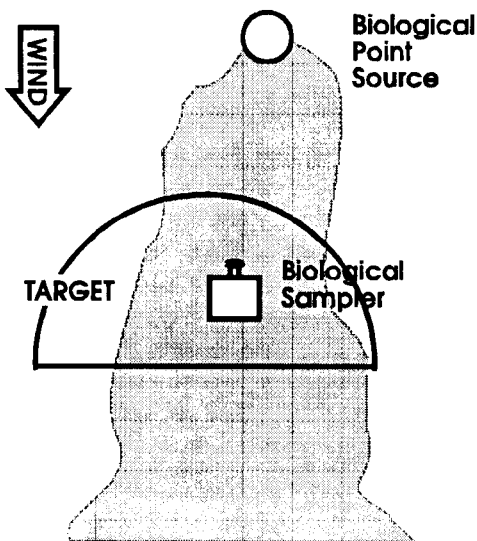

Figure 5-15a. Correct Placement of Sampler.

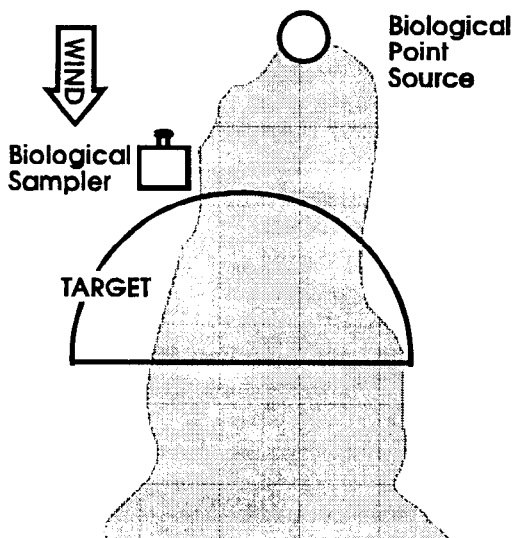

Figure 5-15b. Incorrect Placement of Sampler.

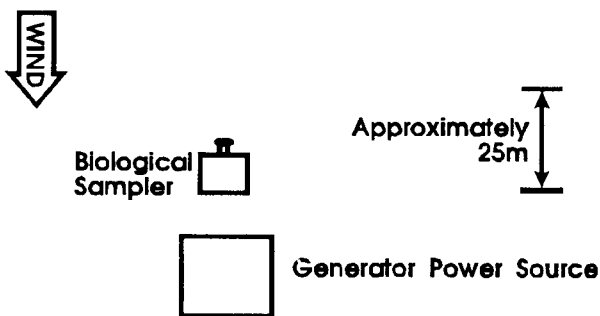

Figure 5-15c. Correct Placement of Sampler With A Generator Power Source.

take solid samples in an area where agent drops are suspected. You also need to take solid samples a short distance away from the actual suspected area. These are for comparison. LABEL everything with a number and write down the coordinates of the area from which you took the sample. Otherwise, write down a description of the area so it can be located on a map. You have labels and marking pens for this very important part of sampling.

## How to Sample

### GASES - Unbagged Pack

Remove the equipment marked with YELLOW circles for gas sampling. The battery powered air pump is connected to the clear tubing. This, in turn, is connected to one of the adsorption tubes (either end), which is stored in the glass tube. The pump is turned on (small switch on front). If you have trouble turning on the switch with gloves on, use the small screwdriver to push the switch on and off. It is already set for large volume flow. Place the pump and tube in the area to be sampled. About 20 minutes is enough. After this time, disconnect the tube and place it in the steel tube holder. A small piece of Teflon tape can be placed over the end of the tube before you screw the cap on. Tighten the fitting (nut) with the pliers. Place a label with an ID number on the tube. The sample is now ready to bring back.

This kit also contains the cooling box. If you collect leaves or samples which might rot (or obvious agent powders), place them in the box. You are given two cold bags to cool the samples down. Squeeze them and place them in the box with the samples. Put the box lid securely on. Connect the batteries to the cooling unit. Place labels on the box lid with ID numbers on the samples, or on containers, if you used them to contain the samples. The samples are ready to bring back.

### LIQUIDS - Unmarked Packs

All equipment to be used for liquid sampling is marked with small red labels. To sample water which may contain agent, you need three items: The plastic 60 mL syringe, a three-way valve, and a Sep-Pak cartridge. Remove the tip protector from the syringe. Also remove the three protectors from the three-way valve. Connect the three-way valve and the syringe so that the green cap of the valve is pointing away from the syringe. The small handle on the valve lets you pull water up into the syringe and send it off in a second direction. Now, connect the Sep-Pak (short end) to the green tip end of the three-way valve. You need to prewash the Sep-Pak before sampling. Do this by setting the valve handle 90 degrees to the aligned syringe, valve, Sep-Pak system.

Place the tip of the open end of the Sep-Pak into the bottle containing **methanol**. Draw the contents of the bottle into the syringe. Now, place the valve handle in line with syringe, valve, Sep-Pak system, and eject the methanol out the side opening of the valve. Do the same thing with the bottle containing **water**. You are ready to sample. Do this by pulling the sample up through the Sep-Pak (valve 90 degrees to system). Eject the used sample by changing the valve setting (valve in line with the system). Label the Sep-Pak with ID number on either white tape or label, along with the pH number (see below). Place the Sep-Pak in one of the small plastic bags.

**Check the pH** of the water from which you took samples before you leave the sampling area. Do this by placing the tip of one of the pH indicator strips into the water. Compare the color of the strip with that on the box. Write the pH number on the label of the Sep-Pak sample.

**To sample possible liquid agents** or other liquids, you are supplied with small plastic pipettes. Draw the liquid into the pipette then expel (squeeze the bulb) the liquid into one of the small plastic, white bottles. Screw the cap shut and place this bottle into the next largest sized plastic bottle. A piece of Teflon tape can be placed over the grooves of the bottle before you screw the cap shut. This gives a better seal to the cap. If there are any spills on the outside of the bottle, wipe them with the gauze pads and discard the gauze. Label this bottle with an ID number. This bottle and others can now be placed in the large plastic bottle for safe transport. If you don't find any liquid agents, these plastic bottles can be used for solid samples.

### **Solid - Unmarked Packs**

To sample solids, including contaminated dirt, you can use the plastic scoop, tongs, or the plastic spatula. A pair of scissors and a knife are also available for cutting samples. Place the solid samples in plastic bags and label each of the bags with an ID number or other information. If you have empty plastic bottles, these can be used for solid samples.

### **General Packaging Procedures**

Packing of environmental samples. Samples should be double wrapped or bagged.

Place the Mylar bag or glass container containing the sample into a corner of a second mylar bag. Remove excess air and twist the neck of the bag until it forms a tight coil with the bag snug around the sample bag or container. There should be no air pockets. Make a gooseneck in the bag by folding the coiled neck in half and wrapping it tightly with tape. Mark bag with identification numbers of samples within.

Collectors should be encouraged to collect the samples in quantities that do not exceed 10 cm in diameter and 14 cm in length to facilitate subsequent handling and storage in the laboratory. In addition, excess bagging by collectors should also be discouraged. However, DO NOT break down and repackage samples to meet the above requirements.

Place any breakable containers in more rigid containers, with protective absorbent material (vermiculite, styrofoam, excelsior or charcoal-impregnated wadding) to protect them from puncture or breakage.

### **Preservations and packing for transport.**

In general terms, the lower the temperature, the longer the life of chemical or biological warfare agent samples. Samples must therefore be at least refrigerated, whatever their nature.

If all the samples cannot be chilled, priority should be given to cooling samples of vegetable and biological materials.

In the field, insulated boxes having a polystyrene interior with compartments to hold flasks may be used, with bags being loosely laid in them.

A sufficient quantity of pre-chilled refrigerating packs (camping-type bags containing polyethylene glycol) can also be placed in the box. Empty spaces should be filled with vermiculite, styrofoam, excelsior or charcoal impregnated wadding.

### **Labeling.**

Tags or adhesive labels should be affixed to each sample container. On each should appear a code number which clearly refers to the accompanying sample data sheet that documents the nature and circumstances of collection.

### **Sampling**

LA\* = 850115-002-JD  
 LA = Sample was acquired by collector in Laos  
 850115 = Sample obtained on 15 January 1985  
 002 = This is the second sample obtained on 15 January 1985 by the collector  
 JD = The sample was collected by John Doe

\* See Annex B for country codes

Place the sample in a zip-lock bag if available.

Place sample in a metal can. Line inside with absorbent packing material. The can helps absorb shock from rough handling during shipment.

### **Ice Chest.**

Standard polyethylene or metal ice chests are the most easily procured items which can be used for tram-world shipment of BW samples. The most easily used size is about 24 inches long by 18 inches high by 15 inches deep. This size permits the sender to ship two or three

sizes of pound metal cans in each chest with sufficient coolant to maintain freezing temperatures for about four days. Additionally, each chest remains at a weight which can be handled by a single individual.

**Coolants.**

The best coolant available in most areas is dry ice. It maintains low temperatures for several days and can be handled easily. Blue ice, a plastic-containerized refrigerant, can be used if available but will not maintain freezing temperatures for as long as dry ice. Standard ice should only be used as a last resort because of its rapid melting rate and the possibility that melted ice may contaminate samples.

**Internal Insulation.**

Even though a commercial ice chest provides good insulation of both the samples and the coolant, extra insulation and cushioning should be placed around the metal cans inside the chest. Newspapers, plastic bubble wrap and foam rubber may all be used with almost equally good results.

Label Ice Chest:

Commander Chemical Research Development and Engineering Center ATTN: SMCCR-OPF Aberdeen Proving Ground, Maryland 21010

The Commander, CRDEC will notify the Commander of the Technical Escort Unit. This unit controls transportation of the samples to their final destination. They will intercept the samples upon arrival at a CONUS Airport.

**WARNING**

Under no circumstances should suspected toxic samples or munition systems be shipped to CONUS technical centers or intelligence agencies without prior approval by the recipient. \* NOTE: OCONUS pick-up by technical escort personnel may be possible.

**Witness Interview**

The witness interview may play the most important role in sample acquisition. Information received can aid in the identification of the sample. Interviewers should insure that testimony accurately describes scientific reality and not a social or political "truth". Interviewers should also avoid yes or no questions. Below is a list of questions that could be asked during an interview:

Name:

Where can you be located in the future?

How was the sample obtained?

Where was the sample obtained?

Were you present during the attack?

Explain what happened if yes.

Describe your symptoms during the attack (durations, how severe, other people affected?)

Any problems with your - head?, eyes?, breathing?, skin?

These questions are designed to allow an interviewer to note MOST relevant details of testimony given by personnel associated with alleged use of chemical or biological warfare agents. Do Not consider the questions to be all inclusive.

**Acquisition Reporting**

An electronic report should be forwarded by the collection team upon acquisition and shipment of samples to report information that has been obtained. Information should be forwarded through the nearest diplomatic or consular post, intelligence agency, or if neither are available, through the nearest U.S. military unit having secure radioteletype communications.

The team should insure that the acquisition message has been properly classified.

The acquisition report should include the following addressees at the minimum:

SECSTATE WASHDC  
 SECDEF WASHDC//OSD-ISA//  
 JCS WASHDC//J-3/J-S  
 CIA WASHDC//OSWR-STD-LSB//  
 DA WASHDC//DASG-PSP, CDR, USAMRDC FT  
 DETRICK MMD//  
 DIA WASHDC//DT-3B/DT-5A//  
 DIR AFMIC FT DETRICK  
 MD//AFMIC-CR/AFMIC-SA//  
 DA WASHDC//DAMI-FIT/DAMO-NCC/SAUS-C//  
 CMTD USACMLS FTMCCLELLAN  
 AL//ATZN-CM-CC//  
 CDR CRDECAPG MD//SMCCR-OPF//  
 CDR FSTC CHARLOTTESVILLE  
 VA//AIAST-FM/AIAST-CW//

The action addressee is:

Cdr, CRDEC, APG MD//CBATEB//

An acquisition message will contain the following information:

The sample identification number will be a part of the subject line if only a single sample is referred to in the text. Otherwise, the sample number will be referred to within the message body with its background information.

The date the sample is to be shipped, the mode of transportation, courier identification, air bill of lading number, flight number, destination and estimated time of arrival will be included if the sample is to be shipped immediately.

Background information surrounding the sample.

If the circumstances surrounding acquisition of a sample were questionable, appropriate information must be included.

If a portion of the sample or information concerning the sample has been shared with a nation or an agency not shown on the message address, or if another country or agency has acquired a sample from the same event or area, this should be indicated in the acquisition report.

A recommended priority and rationale for analysis should be included in order to guide the analysis center as to the team's assessment of the potential value of the sample.

All details which relate to the acquisition of the sample should be included regardless of how insignificant they may seem to the collector.

Disposition of samples should be made according to their physical category.

### Evacuation of Samples

Biological samples must be evacuated to the appropriate laboratory facilities for confirmation of a biological attack. Under normal circumstances labs will

be established in the theater of operations to minimize confirmation time. CONUS labs will also be utilized to verify the results of the theater labs. This information will then be disseminated to subordinate units to insure that adequate protective measures are implemented for protection of both civilian and military personnel. Confirmation of an enemy biological attack will also be reported to the National Command Authority (NCA) for a decision concerning the appropriate military and diplomatic response. Figure 5-16 shows the standard chain of custody for the evacuation of biological samples.

- Suspected
- Biological
- Attack
- Bio-Medical
- Environmental Sample
- Unit S-2
- Technical Intelligence Foreign Materiel Intelligence
- Unit
- Tech Escort
- In-Theater Labs
- CONUS Labs

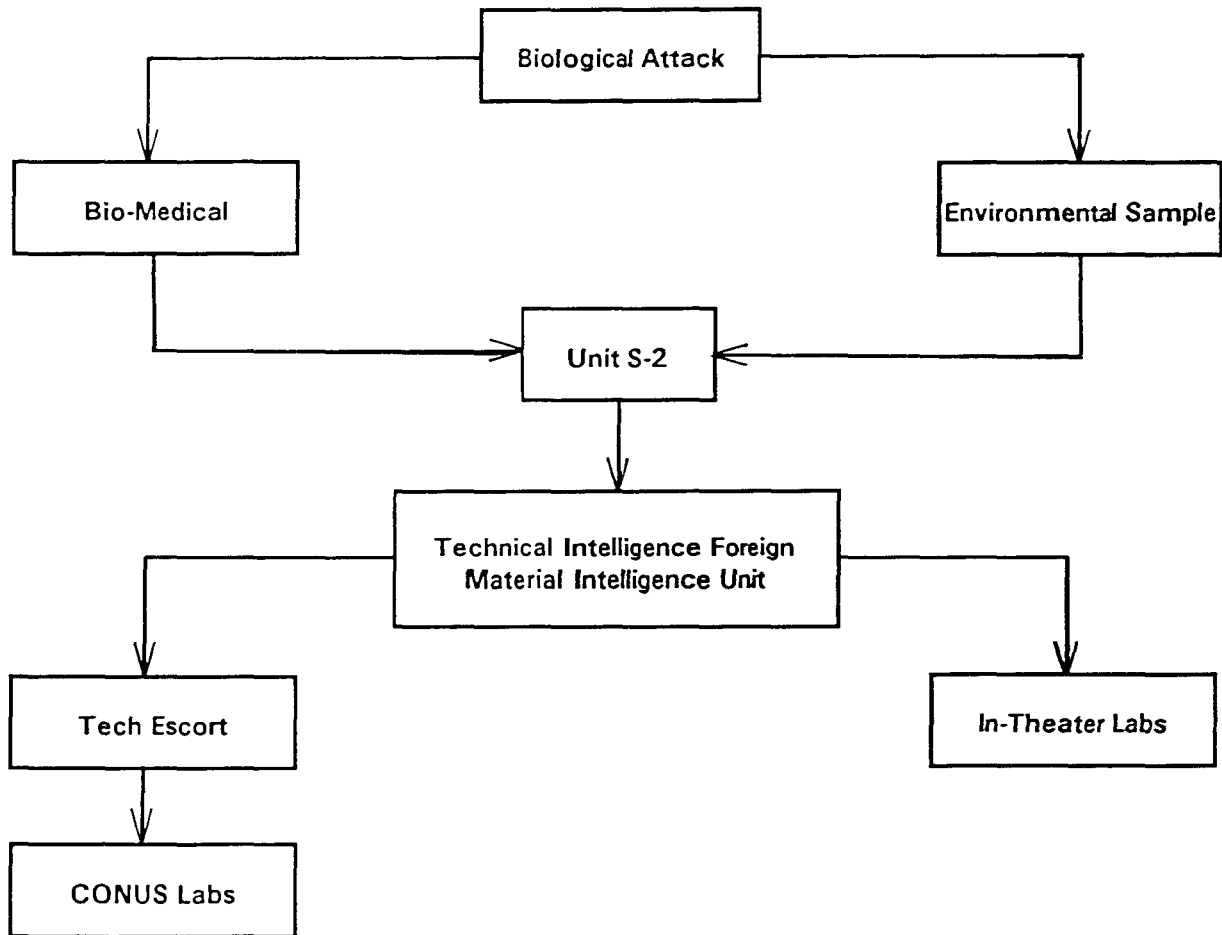

Figure 5-16.

## Chapter 6

# Civilian Chemical Hazards

Every nation in the world has some form of hazardous chemical production or storage facility. Most of these chemicals are used for peaceful purposes and are considered to be in one of the following categories:

- Agricultural - includes insecticides, herbicides, fertilizers . . . etc.
- Industrial - chemicals used in manufacturing processes or for cleaning.
- Production and Research - chemicals (as well as biological agents) used in research or are produced in a facility.

Damage or destruction of a facility or storage site; or any act that creates the unexpected release of civilian chemical products into the environment will present unique challenges to U.S. and allied Armed Forces, as well as the citizens of the Host Nation (HN). Once released, these hazards may cause immediate or delayed incapacitation or death. To safeguard friendly forces and civilians from the potential hazards, peacetime and tactical chemical contamination avoidance principles must be carefully blended.

Civilian chemical compounds may not be detectable by the standard chemical detection devices of tactical units (see Chapter 3 description of these devices). Civilian compounds may not be detectable with the human senses and may cause symptoms that are different than those symptoms from war chemicals.

To minimize the effects or hazards resulting from the damage or destruction of a chemical or biological facility, prior planning must occur. When friendly units are required to operate in an area where such a facility exists, the chemical staff must:

- Coordinate, through G5/S5, with the HN emergency response teams. These teams may be from the HN government, armed forces or from the facility itself.
- Identify what chemical or biological material is present, what type of contamination hazard is present, and how far will the contamination hazard extend.
- Determine whether standard Chemical Defense Equipment (e.g., protective mask, boots, suit, gloves) will protect against the potential harmful effects of released compounds.
- Coordinate with Divisional Chemical for technical assistance
- Coordinate with higher headquarters and HN to identify the availability of CAIRA (Chemical Accident/Incident Response and Assistance) teams Technical Escort units or similar civilian agencies available to assist if required.

- Establish evacuation procedures for noncombatants. Identify a chain-of-command for supervision and coordination of the clean-up effort.

In the event civilian chemical compounds are released the following steps should be taken immediately by the tactical units within the area:

- Notify higher, lower, and adjacent units.
- Start continuous monitoring with available detection equipment. Assume MOPP4.
- Secure the area around the facility. Establish a security perimeter of 620 meter radius around the sight. From this perimeter, draw a 10 km radius to indicate the potential downwind hazard zone (refer to Figure 6-1).
- Evacuate all personnel from within the 620 meter security zone. All personnel within the 10 km hazard zone should assure full chemical protection (MOPP4) or be evacuated from the area. Maintain this posture until relieved by appropriate response team or Military Police.
- The perimeters of the security or hazard zone may increase or decrease after the response team(s) arrive on scene depending upon agent involved, extent of damage and weather conditions.

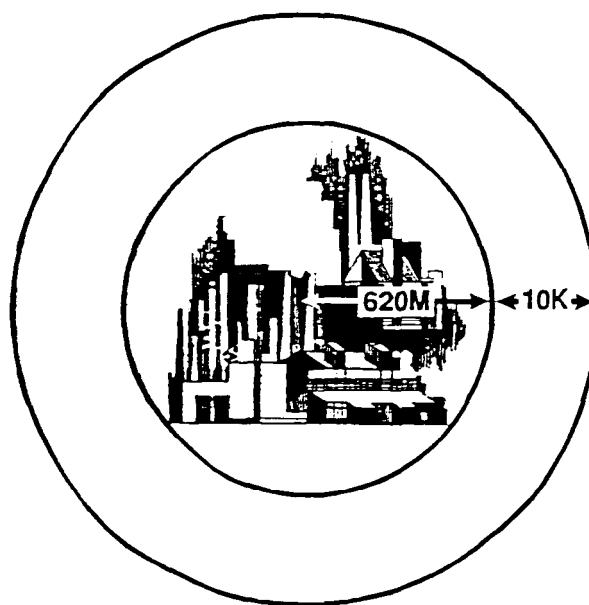

Figure 6-1. Security and Hazard Zones.

## Appendix A

# CB Operational Situation Contamination Avoidance

This appendix provides a series of operational situations that outline how contamination avoidance tactics, techniques, and procedures (TTP) can be applied. The various situations are designed to assist commanders and chemical staff personnel in tactical operations. The TTP included are not designed to replace Army Training and Evaluation Plan (ARTEP) standards, nor any other listing of collective tasks, but is intended to be an operational contamination avoidance checklist. These checklists are not all inclusive and may be adapted or modified for local use.

### Platoon Through Brigade Task Force Chemical and Biological Operations Checklist

Situation: Commander directs units to prepare for operations in a chemical or biological environment. The following specifics apply-

- a. Enemy is capable of offensive chemical or biological weapons employment.
- b. Unit is provided intelligence on enemy NBC capabilities and likely courses of action.
- c. NBC threat status (chemical or biological) is Serial 2 or higher.

#### Platoon/Company Actions

1. Authorized unit detection and individual protective equipment is on hand, operational and issued per unit SOP.
2. Commanders perform MOPP analysis based on METT-T and higher headquarter's guidance.
3. Immunizations are updated and field sanitation measures are enforced.
4. Nerve Agent Pretreatment (NAP) and ciprofloxin tablets are provided to soldiers.
5. OPSEC, dispersion, cover and concealment are practiced.
6. Unit receives and correctly interprets periodic Chemical Downwind Message (CDM).
7. Unit adopts NBC contamination avoidance measures such as covering supplies and equipment with NBC Protective Covers (PC).

#### Battalion/Task Force Actions

1. Oversee subordinate unit actions.
2. Prepare CDM report and send to subordinate units.
3. Ensure contamination avoidance measures are initiated around the headquarters complex IAW SOP.
4. Ensure chemical defense equipment (CDE) shortages are placed on order and contingency stocks are serviceable and deployed IAW SOP.

## Platoon Through Brigade Task Force Chemical or Biological Checklist

Situation: Commander directs unit to prepare for a chemical or biological (toxin) attack. The following specifics apply:

- a. The enemy has or is likely to employ chemical or biological (toxin) weapons.
- b. Chemical/biological weapons employment is considered to be a likely course of enemy action.

### Platoon/Company Actions

1. Subordinate units are alerted.
  2. Commander(s) specify appropriate MOPP levels; establish automatic masking criteria; and, if MOPP 0 is assumed, determines the location for chemical protective clothing based on METT-T.
  3. Unit continues the mission while implementing actions to minimize casualties and damage.
    - a. Personnel, equipment, munitions POL, food, and water are protected from contamination.
    - b. Detection paper is placed to provide visibility and maximum exposure to liquid agents.
    - \*c. OPSEC, dispersion, cover and concealment are practiced so the unit may avoid being targeted.
    - d. Chemical/biological detectors, samplers, and alarms are checked and prepared for use.
    - \*e. Ensure unit has update CDM on hand.
    - f. Chemical Agent Alarms, biological samplers, LP/OP, and air guards are employed as required and/or the tactical situation permits.
- \* Company Only

### Battalion/Task Force Actions

1. Alert subordinate units and elements of the Task Force.
2. Monitor the unit's MOPP status.
3. Ensure subordinate units have taken measures outlined by unit SOP.
4. Ensure subordinate units have received the most current CDM.
5. Plan for possible decon support, establish decon priorities, locate hasty and possible detailed decon sites, and coordinate with the BDE HQ.
6. Ensure biological agent samplers are prepared for operation.



## **Platoon Through Brigade Task Force Chemical or Biological Checklist**

Situation: The commander directs the unit to respond to a chemical/biological agent (toxin) attack. The following specifics apply:

Subordinate unit or units or the battalion/task force is (are) subjected to a chemical or biological agent (or toxin) attack.

### **Platoon/Company Actions**

1. All personnel automatically mask, sound alarm, decontaminate themselves as required, assume MOPP 4, and administer self-aid and buddy-aid.
2. If the unit has access to a Biological Agent Sampler, (an XM2 or Commercial Sampler) activate sampler.
3. The Chain of Command and communications are restored, and the unit continues with the mission.
4. In the event of a biological attack and the unit does not possess a sampler, unit should collect samples with either the M34 Biological Agent Sampling Kit or CBASK.
5. Adjacent units are warned immediately of the potential downwind vapor hazards.
6. Unit identifies type of agent and submits an NBC 1 Chemical or Suspected Biological Report as the mission permits.
7. For attacks that leave liquid or solid contamination on equipment, personal, or terrain, perform the following:
  - a. Conduct personal wipedown and operators spraydown.
  - b. Warn MEDEVAC of contamination casualties. KIAs are wrapped and marked.
  - c. Mark contaminated area and relocate to a clean area if the mission allows.
  - d. Determine where and when further decon can be accomplished if necessary.
  - e. Coordinate for decon and resupply of protective clothing and decontaminates.
  - f. Ensures contaminated BDOs are exchanged within 24 hours after being contaminated.
  - g. Replace contaminated NBC-PCs within 24 hours.
8. For nonpersistent agents, the unit:
  - a. Conducts unmasking procedures.
  - b. Treats casualties and prepare for evacuation as the mission permits.
  - c. Service detection systems to ensure operational status.
  - d. Service XM2 or commercial samplers to ensure operational readiness.
- \*9. Receive NBC 2 Report, plot potential hazard area and inform the commander.

\* Company Only

### **Battalion/Task Force Actions**

1. NBC 1 Reports are received and passed to subordinate, adjacent, and higher units.
2. NBC 1 Reports are consolidated to form an NBC 2 Report. The NBC 2 Report is posted to the situation map as an overlay. The report is passed to subordinate, adjacent, and higher-units.
3. NBC 1 (Follow-up) Report is requested to identify the toxic agent. The hazard area is predicted and disseminated to subordinate/ slice units via NBC 3 Report.
4. XM2 or commercial biological samples obtain sample and forward to area lab for analysis.
5. Subordinate unit damage assessment is evaluated. If required, assistance is provided to the unit for reestablishing command and control. This report is passed to the battalion S1 and S4 for action and/or information.
6. If attack is determined to be a biological attack:
  - a. If agent is determined to be anthrax, soldiers must complete immunization program and start taking ciprofloxin antibiotic tablets.
  - b. If agent is unknown, all attempts must be made to assist in the identification of the agent.
7. Decontamination requirements are determined based on METT-T, extent of contamination and the availability of assets.
8. If decontamination is required and METT-T conditions permit, a decontamination request is prepared IAW SOP and sent to the supporting chemical unit provided it is part of the Battalion's Task Force. If the chemical unit is not available, the request is forwarded to higher headquarters. Decontamination priorities are determined and followed in either case.
9. Contingency stocks are reordered to replace used items.

## Platoon Through Brigade Task Force Chemical or Biological Checklist

Situation: The commander directs the unit to conduct post attack operations. The following specifics apply:  
Unit or elements of the task force have been subjected to a chemical or biological attack.

### Platoon/Company Actions

1. Unit has undergone decontamination operations and casualties have been evacuated.
2. Unit reorders CDE equipment (i.e., MOPP suits, filters, NBC PCs, M258A1 refill kits . . . etc).
3. If unit has not yet determined whether or not the attack was biological/chemical, efforts continue to make this analysis. Efforts continue to identify what agent was used. This will be done by:
  - a. M256A2 kit.
  - b. Chemical Agent Monitor (CAM).
  - c. Sampling with XM2 biological agent sampler or commercial samplers.
  - d. Obtain samples with either M34 kit or CBASK. Samples forwarded to area lab for analysis.
4. If the units must continue to operate in or occupy the contaminated area, the unit should:
  - a. Continue efforts to refine the contamination hazard area and extent by continued sampling/detection.
  - b. Adjust or improve MOPP as required.
  - c. Mark contaminated areas and identify "hot spots".
  - d. Monitor contamination decay or covering to determine when natural decay may render the area safe.
  - e. Be alert for "transient contamination", the spreading or movement of contamination by natural sources (i. e., wind, rain, runoff, rivers . . . etc) or by human sources, (i. e., vehicle traffic, rotorwash . . . etc).
5. In the event of biological contamination:
  - a. If the biological agent is reported to be Botulinum toxin, affected personnel must begin antibody treatment.
  - b. If the biological agent is reported to be Anthrax, soldiers must complete immunization program and begin taking the ciprofloxacin antibiotic tablets.
  - c. If the biological agent is unknown, all efforts must be made to assist medical personnel in the identification process.

### Battalion/Task Force Actions

1. Ensure attacked unit has completed necessary decon measures and evacuates casualties.
2. Receives report from area lab on agent analysis. Inform higher headquarters of results.
3. Ensure attacked unit and medical unit in support re-orders CDE used.
4. If attack was of biological origin:
  - a. Inform supporting chemical unit for decon operations.
  - b. Ensure that the personnel attacked take appropriate antibiotic or antitoxin, if available.
  - c. Inform medical personnel to be alert to potential infected casualties.
5. Continue to refine the limits and extent of the contaminated area and inform the commander on the effects of contamination on future operations.
6. Monitor natural decay of agent. Be alert to conditions which may cover or move contamination to previously clean areas. This may occur through natural sources (i. e., wind, water . . . etc) or man-made sources (rotorwash, vehicle traffic . . . etc).
  - a. Take periodic soil samples and air samples with XM2 or commercial samplers and forward to the area lab for analysis.
  - b. Monitor terrain with M8/M9 paper, CAM or M256A2 kit for chemical contamination.
  - c. Be prepared to advise commander on when the agent is expected to decay to a safe level.

## **Platoon Through Brigade Task Force Chemical or Biological Checklist**

Situation: The commander directs the unit to operate in a chemical/biological agent (toxin) contaminated area. The following specifics apply:

Unit must remain in a contaminated area.

### **Platoon/Company Actions**

1. Unit continues the mission.
  - \*2. Using an NBC 1 or 2 Report from higher HQ or an adjacent HQ, the unit prepares a downwind vapor hazard prediction. The commander is advised of estimated cloud arrival time, and subordinate units are notified.
  3. Chemical agent alarms are employed per unit SOP if the situation permits, it or an LP/OP is used. In the event of a biological attack, and an XM2 or commercial sampler is available; activate sampler.
  4. When an NBC Report is received, plot it to update previous estimates.
  5. Commanders perform a MOPP analysis to determine level of protection.
  6. Unit reacts to the arrival of the downwind vapor hazard and at a minimum assumes a "Mask Only" posture.
  7. Commander conducts unmasking procedures if appropriate, and adjusts protection as appropriate by using MOPP analysis.
- \*Company Only

### **Battalion/Task Force Actions**

1. Units receive warning from higher or adjacent units in the form of an NBC 2 or NBC 3 Report or an NBC 1 Report from subordinate or adjacent units.
2. Prepare a downwind vapor hazard prediction and determine the effects. The units within or close to the predicted area are alerted to the possible downwind hazard.
3. Units continue the mission. If and when the unit is within the downwind hazard, follow steps for responding to a chemical/biological attack (page A-3).
4. Battalion/Task Force Commander is advised of the estimated cloud arrival time, chemical agent, extent of downwind vapor hazard, and an estimation of the duration of the contamination.
5. The commander determines the course of action and MOPP level based on METT-T, guidance from higher HQ, and the advice from the battalion/Task Force Chemical Staff.
6. The commander's guidance is sent to the subordinate units.
7. The subordinate units emplace alarms, biological samplers and other detection IAW SOP.
8. Ensure subordinate units are complying with the commander's guidance and report the arrival of the agent cloud.

## Platoon Through Brigade Task Force Chemical or Biological Checklist

Situation: The commander directs the unit to respond to a chemical/biological agent (toxin) contaminated area. The following specifics apply:

Unit must remain in a contaminated area.

### Platoon/Company Actions

1. Unit continues the mission.
  - \*2. Commander specifies MOPP level needed to provide required protection and adjusts work rates and activity to prevent MOPP heat stress.  
*NOTE: Until positive identification is made to determine whether the snack was a chemical or biological agent; unit should remain in MOPP 4 for a minimum of 4 hours.*
  3. Commander estimates the duration of contamination and the time of stay within the contaminated area and, as required, initiates actions to maintain unit effectiveness.
    - a. Buddy system is employed to watch for symptoms of chemical (toxin) agents, stress from heat and encapsulation, and administer immediate first aid.
    - b. Water consumption is supervised to ensure every soldier consumes 1 quart every 3 hours (every 2 hours if the temperature is above 80 degrees F).
    - c. Clean areas are located where soldiers can be rotated to eat and rest.
    - \*d. Arrangements are made for MOPP gear exchange if contaminated soldiers must stay in MOPP for over 24 hours.
  4. Contamination avoidance and hasty decon techniques are used to minimize the spread of contamination.
- \* Company Only

### Battalion/Task Force Actions

1. Unit continues the mission.
2. Ensure subordinate units continue to monitor area for hazard duration and/or clean areas.
3. Ensure subordinate units continue to practice contamination avoidance procedures IAW SOP.
4. Ensure CDE is reordered when required.
5. Coordinate with higher headquarters for decontamination support.

## Platoon Through Brigade Task Force Chemical or Biological Checklist

Situation: The commander directs the unit to cross a chemically or biologically contaminated area. The following specifics apply:

- a. Subordinate units or the Battalion/Task Force must cross an area contaminated with persistent chemical or biological agents.
- b. The unit is moving and the reconnaissance teams discover that the area in which the unit must cross is contaminated.

### Platoon/Company Actions

1. NBC Report and/or contamination overlay is posted to the situation map. Unit conducts or requests surveys of different routes if time permits.
2. Commander uses available information to determine the best route based on contamination avoidance principles and mission requirements.
- \*3. Advance party/advance guard/point has chemical detection supplies and equipment to test for contamination and downwind vapor hazards along the route. They report contaminated areas unless otherwise directed by the commander.

*NOTE: If the unit possessor has access to an NBC Recon System (NBCRS), this vehicle should be used with the advance party.*

4. Personnel and equipment are prepared for crossing by:
  - a. Increasing MOPP as required.
  - b. Ensuring M8/M9 Paper is placed on clothing and equipment.
  - c. Ensuring chemical alarms are serviced and mounted on vehicles or carried by personnel IAW SOP.
  - d. Ensuring M11 decon apparatus and/or M13 DAPs are serviced, filled and mounted on vehicles.
  - e. Ensuring M256A1 detector kits are issued to operators.
  - f. XM2's or commercial samplers cannot be operated on the move. Units, however, should obtain samples of suspected contamination with either the M34 or CBASK if time and mission permit.
5. Unit crosses the contaminated area using contamination avoidance techniques.
6. After exiting the area, hasty decon should be performed provided the mission is not jeopardized (commander's decision).

\* Company Only

### Battalion/Task Force Actions

1. The unit has or obtains current SITREPS on the contaminated areas. Ensures this information is passed to all effected units.
2. NBC 5 Report and/or overlay is posted to the situation map to aid the commander in selecting the appropriate route.
3. The crossing subordinate unit must receive the most current NBC 5 Report to be used in determining an appropriate route.
4. Route clearance is requested (if required).
5. Notify the crossing unit(s) of decontamination assets available and hasty or detailed decontamination site(s) to be utilized after crossing.
6. If internal decontamination support is not available additional decontamination support will be required, notify the BDE/MUC.
7. Crossing unit receives contingency stocks of CDE, and the unit is prepared to cross the area IAW SOP.
8. Crossing unit executes contamination avoidance techniques IAW SOP.
9. After crossing the area, ensure crossing unit(s) determines their decontamination requirements and request decon support IAW SOP.
10. Notify higher HQs that the crossing is completed, the number of casualties sustained (if any), and the decontamination support requirements and/or decon operations scheduled.
11. Ensure that the subordinate unit reorders contingency stocks of CDE as required.
12. Ensure that the subordinate unit reports the completion of decontamination operations to higher HQs.

## Platoon Through Brigade Task Force Chemical or Biological Checklist

Situation: The commander directs the unit to conduct a chemical or biological survey. The following specifics apply:

- a. A downwind hazard prediction indicates chemical or biological agents may affect the units' operational area.
- b. Areas of interest within the units' operational area may be contaminated with a chemical or biological agent.
- c. Higher headquarters directs unit to conduct a chemical/biological survey in the unit's area of operation.
- d. The tactical situation requires the unit to conduct a chemical/biological survey.

### Platoon/Company Actions

1. Unit initiates or is given an area to be surveyed, plans the survey, and organizes the party. The briefing includes but is not limited to the following:
  - a. Type of recon and/or technique to be employed.
  - b. Reporting requirements.
  - c. Marking requirements.
  - d. Special preparation of vehicle to enhance contamination avoidance.
2. Survey team(s) execute(s) mission as directed.
- \*3. NBC Defense Team submits evaluated data to higher headquarters.
4. Unit decontaminates as required.

\* Company Only

### Battalion/Task Force Actions

1. Unit receives the mission request and/or determines the area to be surveyed. Request support from an NBC reconnaissance vehicle, if possible.
2. Ensure subordinate unit initiates, conducts, and reports survey data IAW the guidance from the requesting headquarters SOP.
3. Alert the supporting chemical unit to the potential need for decontamination of survey party. If the battalion does not have an organic supporting chemical unit, the battalion notifies the MUC.
4. Identify potential decon lamination sites (if required).
5. Ensure subordinate unit reports the start time of the survey, significant finds, and completion time of the survey.
6. Ensure subordinate unit submits the NBC 4 Report as required by the SOP. The report is received, logged in, checked for accuracy, and forwarded to higher headquarters. The battalion keeps a copy of this report.
7. Survey findings are posted or annotated on the situation overlay IAW SOP.

## Platoon Through Brigade Task Force Chemical or Biological Checklist

Situation: The commander directs the unit to conduct decontamination operations (hasty or detailed). The following specifics apply:

- a. Subordinate unit(s) report contamination from a persistent chemical or biological agent.
- b. Personal wipe down has been completed but personnel are still contaminated.

### Platoon/Company Actions

1. Unit determines the extent and numbers of contaminated personnel and equipment.
  - \*2. Unit requests decon support and coordinates for chemical protective clothing and decontaminates for detailed troop decon.
  3. Unit designates decon team, moves to the assembly area which is downwind from the decon site, links up with chemical company's decon unit, and receives a briefing on the decon site operation.
  4. Unit conducts detailed troop decon and sends equipment to the detailed equipment decon site as instructed by the chemical company decon unit's OIC or NCOIC.
  - \*5. Unit conducts detailed troop decon for the chemical unit after it completes its mission and it closes the troop decon site.
  6. Unit completes reconstitution and resumes or awaits the next mission.
- \* Company Only

### Battalion/Task Force Actions

1. Subordinate unit requests decontamination IAW SOP.
2. The commander is briefed on the type and extent of contamination, how long the contaminated unit can stay in the current posture without further decontamination, the availability of a chemical unit support, and a recommendation on which decon should be done.
3. The commander decides if the unit will initiate decontamination operation, and if so, whether the decontamination will be hasty or detailed. The decision is based on METT-T and the advice from the Battalion/ Task Force Chemical Staff.
4. The commander's decision is transmitted back to the requesting unit as follows:
  - a. If the decision is not to decontaminate, the subordinate unit is provided guidance on protective measures to take.
  - b. If the decision is to decontaminate utilizing hasty decontamination procedures then:
    - (1) The battalion requests decontamination support from the chemical unit if decon assets are not organic to the battalion.
    - (2) The subordinate unit is (are) notified of the decision and location of the linkup point of the decontamination site.
    - (3) The battalion notifies the contaminated unit and ensures that their unit deploys the decon team to prepare the site. The unit decontamination team will operate the decon site. The battalion decon team or chemical platoon will do the vehicle washdown for the decon team. If this support is not available, the unit's decon team will operate the site utilizing organic decontamination assets, e.g., M13 DAP and/or M11. The unit decon team establishes entry and exit traffic control.
  - c. If the decision is to decontaminate utilizing detailed decontamination procedures, then the following occurs:
    - (1) The battalion requests detailed decon support from the supporting chemical unit.
    - (2) Subordinate unit is notified about the decision, location of the decontamination site, amount of time the unit has to complete decontamination operations and which unit if any will relieve the contaminated unit in place or assume the

**Battalion/Task Force Actions (Continued)**  
contaminated unit's mission during decontamination.

5. Subordinate unit will be given the time for reporting to the decon site, moving into the predecon staging area, rendezvous, point of contact at the site, route and type of march to and from the site, etc.
6. Battalion will ensure contaminated units decon team operates the decon site IAW SOP. If more than two (2) companies require decontamination, the battalion will coordinate with the MUC for additional decon assets.
7. The contaminated unit reports arrival at the decon site, completion of 50% of the unit, and completion of decon operations to the BN HQs.
8. Battalion reports completion of the decon operations and site closure to the MUC.
9. Subordinate unit reorders contingency stocks of CDE that were expended during decontamination.



## **Platoon Through Brigade Task Force Chemical or Biological Checklist**

Situation: The commander directs the unit to evacuate chemically or biologically contaminated casualties. The following specifics apply:

Unit has sustained casualties that are chemically or biologically contaminated.

### **Platoon/Company Actions**

1. Unit requests medical evacuation based on normal considerations of medical care required, urgency, and the tactical situation. Evacuation requests will be made IAW SOP.
2. Unit informs higher HQs on how many casualties were sustained, type of contamination and mode of evacuation.
3. Casualties are brought to MEDEVAC aircraft or vehicle. Unit will take measures to limit the spread of contamination.
4. Casualty is marked, identify type of contamination and first aid received.

### **Battalion/Task Force Actions**

1. Subordinate unit informs HQ on the number of casualties, type and time of contamination and method of evacuation desired.
2. Notify the subordinate unit that has been designated to provide a ten (10) man detail for patient decon support. Ensure subordinate unit is provided with the time for the detail to report, location of Battalion Aid Station (BAS), and POC at the BAS.
3. Battalion Aid Station (BAS) is notified of incoming casualties. BAS has a ten (10) man detail on hand to assist in decontamination.
4. Notify higher HQs on the number of casualties, type of contamination, and estimated time of arrival (ETA) to the BAS.
5. Notify the supporting chemical unit or higher HQs about the possibility for decontamination support either for the MEDEVAC helicopter or ground ambulance.
6. Ensure that a responsible individual who is knowledgeable in NBC defense is at the BAS to assist in casualty decontamination. This individual must ensure that aircraft or ambulance personnel off load casualty into a designated area which is downwind from the BAS and will assist or ensure the crew of the vehicle or aircraft monitors for contamination.
7. Ensure that the BAS coordinates with the battalion for decontamination (if required).
8. Inform the BAS when to have the ambulance or helicopter report to the decontamination site, from what direction to approach the decon site, and point of contact at the site.
9. Ensure that the ambulance or MEDEVAC helicopter is decontaminated IAW SOP. Decon site will be operated by the detail unit who provides a casualty decon team to the BAS.

## **Platoon Through Brigade Task Force Chemical or Biological Checklist**

Situation: The commander directs the unit to prepare for a friendly chemical strike (CHEMWARN). The following specifics apply:

- a. The unit is notified by higher HQ that a friendly chemical strike will occur in the unit area of operations (AO).
- b. The unit receives CHEMWARN message.

### **Platoon/Company Actions**

1. Unit requires authentication if unsecure net is used.
2. Unit acknowledges warning receipt.
3. Unit relocates if required.
4. Unit implements protective measures prior to strike IAW SOP and maintains protective measures until strike is executed or cancelled.

### **Battalion/Task Force Actions**

1. The unit locates ground zero (GZ) or target area on the map and plots the hazard area.
2. The unit determines which subordinate unit(s) must initiate protective measures or relocate.
3. The commander is briefed on the impending strike and post detonation effects.
4. The unit directs subordinate unit(s) which will be affected to relocate or implement protection measures IAW SOP.
5. The unit notifies MUC when all company and separate platoon-size units in battalion area of operations have been notified.
6. Ensure affected unit(s) take appropriate protection IAW SOP.

## Platoon Through Brigade Task Force Chemical or Biological Checklist

Situation: The commander directs the unit to respond to an unexpected contaminated area. The following specifics apply:

- a. Advance party or reconnaissance team did not detect contaminated area.
- b. Templating (NBC 5 Report) did not accurately depict the boundaries of the contaminated area.
- c. Enemy forces executed attack after reconnaissance was completed.
- d. Maneuver element or unit enters contaminated area unexpectedly.

### Platoon/Company Actions

1. After recognizing the unit is in a contaminated area:
  - a. Elements halt.
  - b. Don protective equipment (MOPP suit, mask . . . etc).
  - c. Each soldier performs personal wipedown, if required.
  - d. Chemical casualties are identified and treated.
  - e. Alert other maneuver elements and higher that contamination has been found.
  - f. If element is in direct-fire contact, continue mission and fight dirt y. If not, proceed with remaining steps.
  - g. Using the M256 Kit or other detection devices, check immediate area for type and amount of contamination.

*NOTE: First "clean" element has found the initial near side of the contamination.*

2. Element in contaminated area will continue forward checking area every 500 meters.
3. Based on METT-T, the maneuver element commander determines which direction the element should move to exit and bypass contaminated area.
4. The first "clean" element, based on the commanders assessment, will move 500 meters to the rear to establish the initial rear side line. Then the element will:
  - a. Turn 90 degrees (left or right) and move 500 meters.
  - b. Halt, and check for contamination.
  - c. If contaminated, turn 90 degrees and move 500 meters to the rear.
  - d. Check for contamination. If no contamination is found, turn 90 degrees in the original direction of travel and move 500 meters. Check area again for contamination.
  - e. Continue process in 4a - d until initial far side line of contamination is crossed.
5. Element finding the initial far side line, or bypass route, should clearly mark the route using either:
  - a. VS-17 panels.
  - b. Colored Smoke.
  - c. Guides.

### Battalion/Task Force Actions

1. Receive initial report from the maneuver element and:
  - a. Plot coordinates on situation map.
  - b. Prepare NBC 4 Contact Report and sent to higher and adjacent units.
  - c. Provide any guidance and/or assistance as possible to maneuver element.
  - d. Inform commander and/or S3 of situation.
  - e. Monitor progress of maneuver element until element has safely transverse area.
2. Report coordinates of bypass route to higher.
3. Inform commander and/or S3 of the bypass route, and status of maneuver element.
4. Coordinate for:
  - a. Medical evacuation, if required.
  - b. Decontamination support, at earliest possible time.
  - c. Replishment of chemical defense equipment (CDE) for maneuver element.
  - d. Further reconnaissance of contaminated area.

**Platoon/Company Actions (Continued)**

6. Once maneuver unit has safely transverse contaminated area:
  - a. Report coordinates of bypass route to higher and adjacent units.
  - b. Report casualties and request for medical extraction, if required.
  - c. If mission permits, conduct vehicle spraydown and MOPP gear exchange or unmasking procedures (which ever is most appropriate, depending on extent of contamination).
  - d. Request decontamination support from higher HQ at earliest possible time.
  - e. Continue mission.

## **Platoon Through Brigade Task Force Chemical or Biological Checklist**

Situation: The commander directs the unit to respond to a civilian chemical accident or incident. The following specifics apply:

- a. Enemy operatives, agents or an attack has created damage to civilian chemical or biological facilities or production plant(s).
- b. Tactical operations has caused the unexpected or unintentional release of chemical or biological material (solid, liquid, or gas) into the environment.

### **Platoon/Company Actions**

1. Alert higher, adjacent and lower units.
2. Immediately secure the area and:
  - a. Start continuous monitoring, with the M256 Kit or similar detection device. Ensure results are reported using NBC 4 Chemical Report format.
  - b. Assume MOPP 4.
  - c. Establish security zone around the area of no less than 620 meters radius. This area may be enlarged depending on chemical agent involved.
  - d. Evacuate casualties from security zone. Casualties should be considered as contaminated and should be contained in one central location. Initiate emergency decon of personnel.
  - e. Identify witnesses for questioning.
  - f. Establish a 10 km downwind hazard zone from the perimeter of the security zone. All personnel within this zone must don MOPP4 or evacuate the area until further notice.
3. Maintain security until released by higher.

### **Battalion/Task Force Actions**

1. Alert higher, adjacent and lower units.
2. Ensure security and downwind hazard zones are established and:
  - a. Casualties are evacuated.
  - b. Request assistance from:
    - (1) Military Police.
    - (2) Medical personnel.
    - (3) EOD teams (if required).
    - (4) Division Chemical section.
    - (5) Host Nation support.
    - (6) DOD response teams..
3. If hazard is in vapor form plot a Type A Case b for plotting purposes. Ensure friendly units and civilians in the predicted downwind hazard area are warned- If the hazard is in a liquid form, with no evaporation hazard present, the 620 meter security zone should be adequate.
4. Maintain security of area

## Appendix B

# Biological Agents

Potential biological warfare agents and their effects are depicted in Table B-1 below.

*Table B-1. Potential Biological Warfare Agents.*

PATHOGENS	MOSTS LIKELY METHOD(S) OF DISSEMINATION	INCUBATION PERIOD (DAYS) <sup>2</sup>	MORTALITY RATES <sup>2</sup>	VACCINE <sup>3</sup>	TREATMENT <sup>4</sup>
<b>Bacteria</b>					
Bacillus Anthracis (Anthrax) <sup>5</sup>	A	1-5	High	+ +	E <sup>6</sup>
Francisella Tularensis (Tularemia)	A	1-10	Low	+ +	E <sup>6</sup>
Yersinia Pestis (Plague) <sup>7</sup>	A, V	2-5	High	+ + +	E <sup>6</sup>
Vibrio Cholerae (Cholera)	I, A	1-5	High	+ + +	E
Salmonella Typhi (Typhoid Fever)	I, A	7-21	Moderate	+ + +	E
<b>Rickettsiae</b>					
Rickettsia SPP (Spotted Fevers Group)	A, V	6-15	Low Moderate	+ + +	E
Rickettsia (Endemic or Flea Borne Typhus)	A, V	4-15	Low	-	E
Rickettsia (Rocky Mountain Spotted Fever)	A, V	3-10	Low/Moderate	-	E
Coxiella Burnetii (Q Fever)	A, V	7-21	Very Low	+	N
<b>Viruses</b>					
Eastern Equine Encephalitis (EEE) <sup>8</sup>	A, V	5-15	Moderate/High	-	N
Venezuelan Equine Encephalitis (VEE) <sup>8</sup>	A, V	2-5	Moderate/High	+	E
Japanese B Encephalitis	A, V	5-15	Low*	+ +	N
Russian Spring-Summer Encephalitis (RSSE)	A, V (Tick)	7-14	Low/Moderate	+	N
Yellow Fever	A, V (Mosquito)	4-5	Low/Moderate	+ + +	N
Dengue Fever	A, V (Mosquito)	5-6	Low	-	N
Variola Virus (Smallpox)	A, D	11-13	High	+ + +	N
Hantaan Virus (Hemorrhagic Fever with/renal Syndrome)	A, V		Low	+	N
Phlebovirus (Rift Valley Fever)	A, V (Mosquito)	4-6	Low	+	N
* Nairovirus (Crimean-Congo Hemorrhagic Fever)	A, V (Tick)	3-7	Moderate	-	N*
Phlebovirus (Sandfly)	A, V (Mosquito)	3-6	Low	-	N
Alphavirus (Chikungunya)	A, V	2-6	Low	+	N
* Arenavirus (Lassa Fever)	A		High	-	N*
Filovirus (Ebola Fever)	A			-	N

Table B-1. Potential Biological Warfare Agents (Continued).

\* Ribavirin shown to have experimental effectiveness.

1. Transmission can be by aerosol - A, direct contact -D, ingestion-I, and vector-V.
2. Incubation periods and mortality rates vary according to a number of factors (e.g., ability of the host to resist infection, infective dose, portal of entry, and virulence of the microorganism).
3. + indicates vaccine available but of questionable value; ++ indicates vaccine available but mainly used in high risk individuals; +++ indicates vaccine used extensively; - indicates no vaccine available.
4. E indicates effective treatment available; N indicates no specific treatment.
5. The mortality rate is lower due to skin form; mortality rate higher due to respiratory form.
6. Treatment must be initiated in the earliest stage of the pulmonary form to be effective.
7. Includes both bubonic and pneumonic forms.
8. Mosquitoes are thought to be the primary vectors, but this has not been proved.

Mortality rates for untreated/exposed personnel.

High = 50% or greater  
 Moderate = 15 - 50%  
 Low = >1 - 15%

TABLE B-2. Lethality and Rate of Action of Selected Toxins.

TOXIN AND TIME TO TOXIC EFFECTS	TOXICITY *	TYPE AND EFFECTS
* In mice if no other information is given.		
<b>Very rapid: 5 minutes</b>		
Anatoxin A (VFDF)	+	Lethal paralytic neurotoxin; chemical nerve agent symptoms.
Conotoxin	++	Lethal snail neurotoxin; bleeding at injection site; muscle weakness.
Palytoxin	+++	Lethal neurotoxin; muscle paralysis; collapse.
<b>Rapid: 5 minutes to 1 hour</b>		
Diphtheria toxin	++++	Lethal; sore throat; swollen glands.
Batrachotoxin	++++	Lethal; frog paralytic neurotoxin; neuromuscular block.
Ricin (injected)	+++	Lethal cytotoxin.
Taipoxin	+++	Lethal; snake paralytic neurotoxin.
Saxitoxin	+++	Lethal; numbness; muscle weakness; incoordination respiratory distress.
Tetrodotoxin	+++	Lethal neuromuscular block; numbness; loss of muscle control; voice loss.
Alpha-latrotoxin	++	Lethal spider neurotoxin; paralytic chemical agent symptoms.
Notoxin	++	Lethal snake neurotoxin; paralytic.
Beta-bungarotoxin	++	Lethal snake neurotoxin; paralytic.
Cobrotoxin	++	Lethal snake neurotoxin; paralytic.
Microcystin (FDF)	+	Lethal cytotoxin; shivering; stupor.
<b>Delayed: 1 to 12 hours</b>		
Ricin (aerosol, skin, oral)	+++	Lethal cytotoxin; nausea; vomiting; cramps.
Staphylococcus enterotoxin B	++	Incapacitant; acute food poisoning symptoms.
Botulinum (oral)	+++	Lethal neurotoxin; drooping eyelids; double vision; dilated pupils; fever; paralysis.
T-2 (skin, aerosol, oral)	+	Incapacitant/lethal cytotoxin; skin reddening, rash, blisters; nausea; bloody vomit, diarrhea.
* extremely toxic, + + + +; very toxic, + + +; moderately toxic, + +; toxic, +		

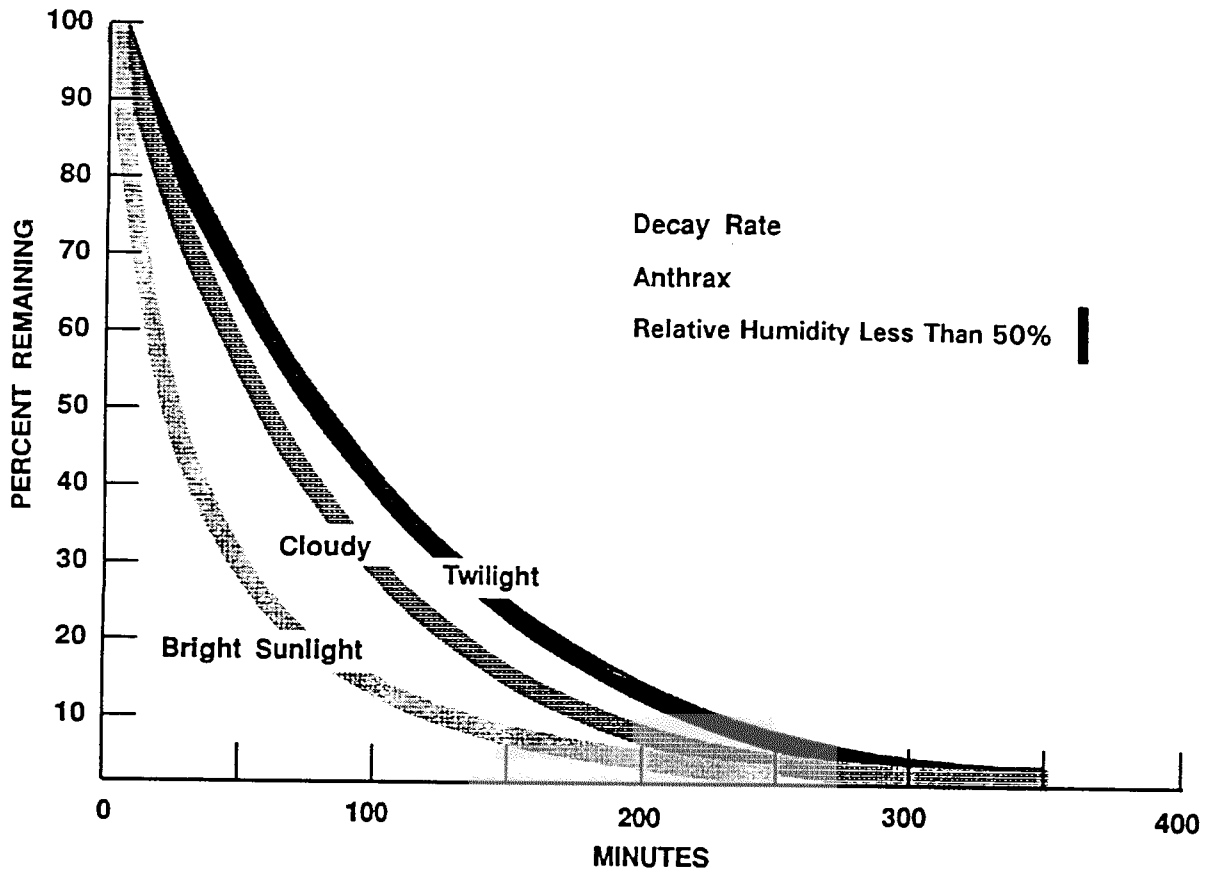

Figure B-1. Decay Rate, Anthrax, Relative Humidity < 50%.



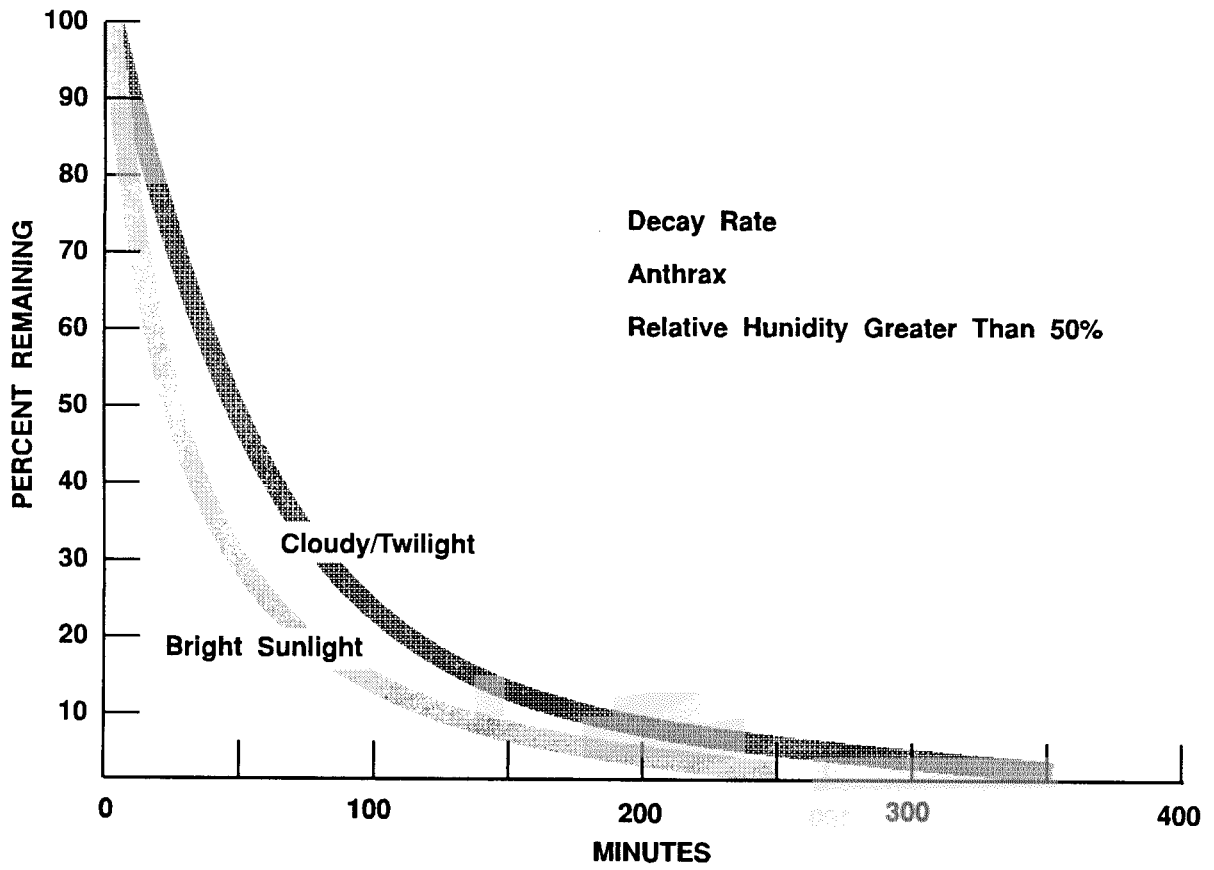

Figure B-2. Decay Rate, Anthrax, Relative Humidity >50%.

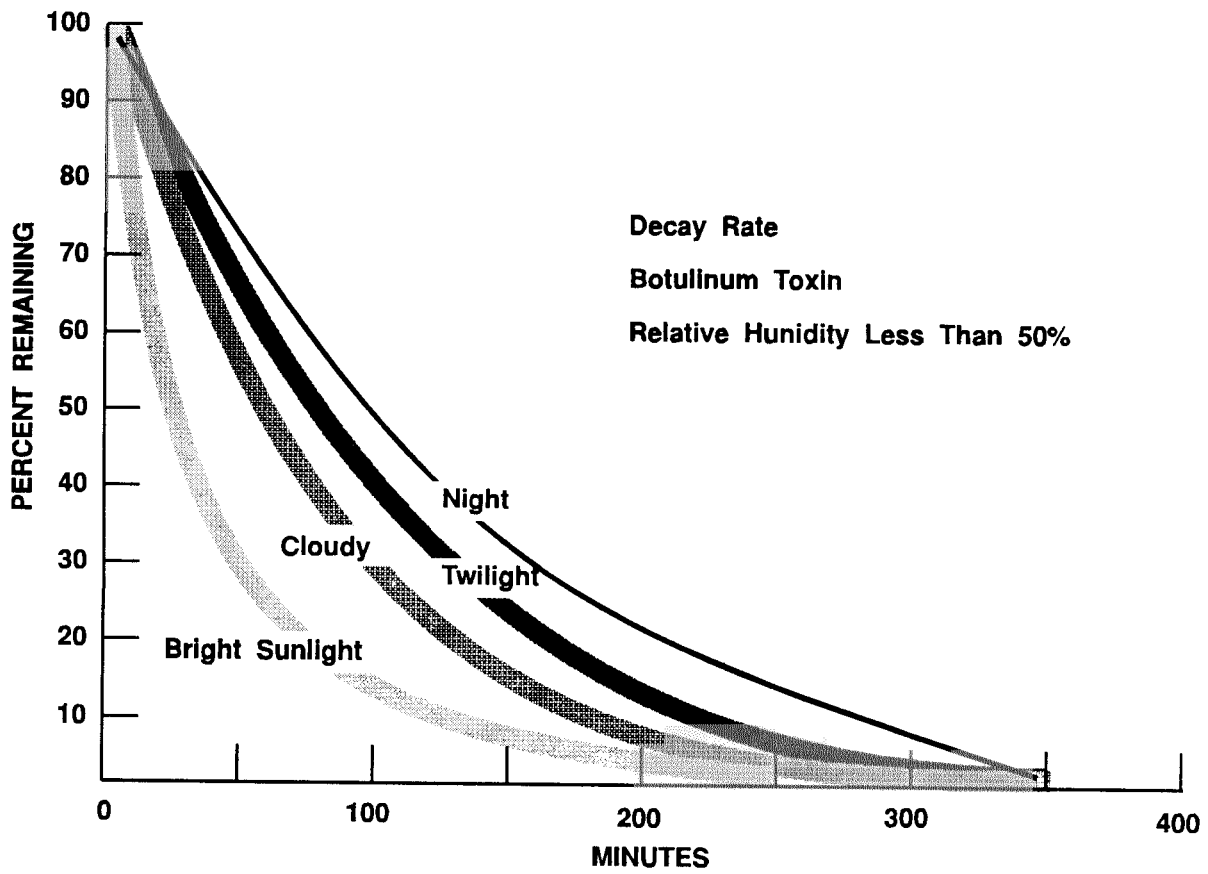

Figure B-3. Decay Rate, Botulinum Toxin, Relative Humidity < 50%.

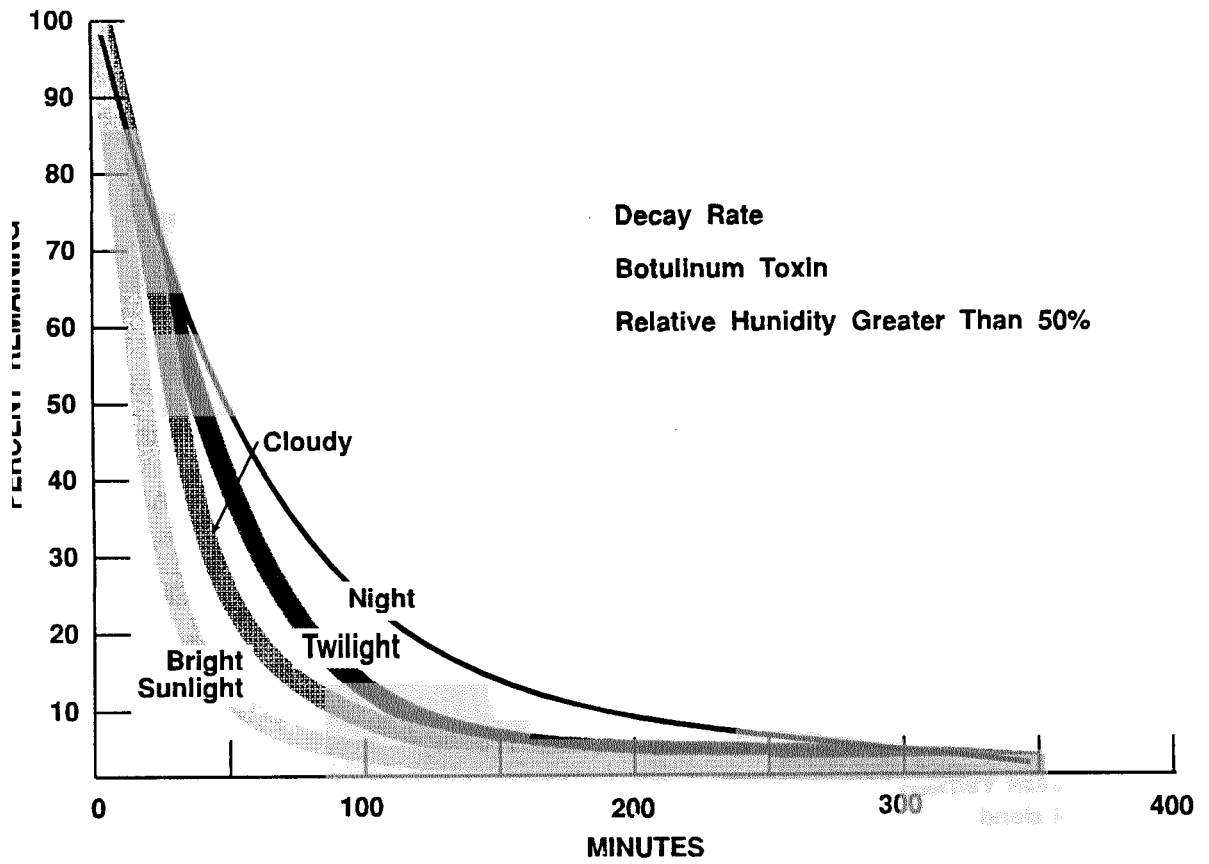

Figure B-4. Decay Rate, Botulinum Toxin, Relative Humidity > 50%.

This section defines current country codes. Geographical areas are listed in alphabetical order. These codes are used in conjunction with the biological sampling form depicted in Appendix C.

COUNTRY

COUNTRY  
CODE

Afghanistan	AF
Albania	AL
Algeria	AG
American Samoa	AQ
Andorra	AN
Angola	AO
Anguilla	AV
Antarctica	AY
Antigua	AC
Argentina	AR
Australia (Including Ashmore, Cartier and Coral Sea Islands Territory)	AS
Austria	AU
Bahamas, The	BF
Bahrain	BA
Bangladesh	BG
Barbados	BB
Belgium	BE
Belize	BH
Benin (Formerly Dahomey)	DM
Berlin	WB
Bermuda	BD
Bhutan	BT
Bolivia	BL
Botswana	BC
Bouvet Island	BV
Brazil	BR
British Indian Ocean Territory	IO
British Solomon Island	BP
British Virgin Islands	VI
Brunei	BX
Bulgaria	BU
Burma	BM
Burundi	BY
Cameroon	CM
Canada	CA
Cape Verde	CV
Cayman Islands	CJ
Central African Republic	CT
Chad	CD
Chile	cl
China	CH
Christmas Island	KT
Cocos (Keeling Islands)	CK

Columbia	CO
Comoro Islands (Including Mayotte)	CN
Congo	CF
Cook Islands (Including Society Islands)	CW
Costa Rica	CS
Cuba	CU
Cyprus	CY
Czechoslovakia	CZ
Denmark	DA
Djibouti	DJ
Dominica	DO
Dominican Republic	DR
Ecuador	EC
Egypt	EG
El Salvador	ES
Equatorial Guinea	EK
Ethiopia	ET
Faeroe Islands	FO
Falkland Islands (Islands Malvinas)	FA
Fiji	FJ
Finland	FI
France (Including Corsica)	FR
French Guiana	FG
French Polynesia	FP
French So. and Antarctic Islands	FS
Gabon	GB
Gambia	GA
Germany, Federal Republic (FRG)	GE
Ghana	GH
Gibraltar	GI
Gilbert and Ellis Islands (Including Phoenix, Central and Southern Line Islands)	GS
Greece	GR
Greenland	GL
Grenada	GJ
Guadaloupe	GP
Guam	GQ
Guatemala	GT
Guinea	GV
Guinea-Bissau	PU
Guyana	GY
Haiti	HA
Heard Island and McDonald Islands (Including Kerguelen, Prince Edward and Croizet Islands)	HM
Honduras	HQ
Hong Kong	HK
Hungary	HU
Iceland	IC
India (Including Sikkim, Laccidive, Andam and Nicobar Islands)	IN
Indonesia	ID
Iran	IR
Iraq	IZ

Iraq-Saudi Arabia Neutral Zone	IY	Norfolk Island	NF
Ireland	El	Norway	NO
Israel	Is	Oman (Including Kuria Mauria Island)	MU
Italy	IT	Pakistan (Including Jammu and Kashmir)	PK
Ivory Coast	Iv	Panama	PM
Jamaica (Including Morant Island and Pedro Cayo Island)	JM	Papua New Guinea	PP
Japan	JA	Paracel Islands	PF
Johnston Atoll	JQ	Paraguay	PA
Jordan	JO	Peru	PE
Kampuchea (Formerly Cambodia)	CBW	Philippines	RP
Kenya	KE	Pitcairn Islands	Pc
Korea, Democratic People's Republic	KN	Poland	PL
Korea, Republic of	KS	Portugal (Including Azores Islands and Madeira islands)	PO
Kuwait	KU	Puerto Rico	RQ
Laos	LA	Qatar	QA
Lebanon	LE	Reunion	RE
Lesotho	LT	Romania	RO
Liberia	LI	Rwanda	RW
Libya	LY	St. Christopher-Nevis	Sc
Liechtenstein	LS	St. Helena (Including Ascension and Tristan da Cunha Islands)	SH
Luxembourg	LU	St. Lucia	ST
Macao	MC	St. Pierre and Miquelon	SB
Madagascar (Malagasy Republic)	MA	St. Vincent	VC
Malawi	MI	San Marino	SM
Malaysia	MY	Sao Tome and Principe	TP
Maldivé Islands	MV	Saudi Arabia	SA
Mali	ML	Senegal	SG
Malta	MT	Seychelles (Admiralty, Aldabra and Assumption)	SE
Martinique	MB	Sierra Leone	SL
Mauritania	MR	Singapore	SN
Mauritius (Including Chagos Island and Rodriguez Island)	MP	Somalia	SO
Mexico	MX	South Africa	SF
Midway Islands	MQ	Spain (Including Balearic Islands, Canary Islands, Spanish North Africa, and Ifni)	SP
Monaco	MN	Spratly Islands	PG
Mongolia	MG	Sri Lanka	CE
Montserrat	MH	Sudan	SU
Morocco	MO	Surinam	NS
Mozambique	MZ	Svalbard and Jan Mayen Islands	JS
Namibia	WA	Swaziland	WZ
Nauru	NR	Sweden	SW
Navassa Island	BQ	Switzerland	SZ
Nepal	NP	Syria	SY
Netherlands	NL	Taiwan (Including Pescadores Islands)	TW
Netherlands Antilles Islands	NA	Tanzania (Including Zanzibar and Pemba Islands)	TZ
New Caledonia	NC	Thailand	TH
New Herbrides	NH	Togo	TO
New Zealand	NZ	Tokelau Islands	TL
Nicaragua	NU	Tonga	TN
Niger	NG		
Nigeria	NI		
Niue	NE		

Trinidad and Tobago	TD	Vatican City	VT
Trust Territory of the Pacific (U.S. including Caroline Islands)	TQ	Venezuela	VE
Tunisia	TS	Vietnam	VM
Turkey	TU	Virgin Islands (U. S.)	VQ
Turks and Caicos Islands	TK	Wake Island	WQ
Tuvalu	TV	Wallisand Futuna Islands	WF
Uganda	UG	Western Sahara	WH
United Arab Emirates	TC	Western Samoa	WS
United Kingdom	UK	Yemen, North (YAR)	YE
USSR (East of 100 degrees)	UR	Yemen, South (PDRY)	YS
USSR (West of 100 degrees)	UW	Yugoslavia	YO
U.S. (Miscellaneous Pacific Islands)	IQ	Zaire	CG
Upper Volta	UV	Zambia	ZA
Uruguay	UY	Zimbabwe	ZI

CHEMICAL DATA SHEET — MONITORING OR SURVEY		DATE	PAGE NO.	NO. OF PAGES
For use of this form, see FM 3-3; proponent of this form is TRADOC.				
UNIT		MONITOR OR SURVEY TEAM MEMBER (Print Name)		
MONITOR OR SURVEY TEAM NUMBER				
MAP USED				
LOCATION/TIME OF TEST OR INDICATION	TYPE DETECTOR USED			AGENT DETECTED
	PAPER	ALARM	KIT	
REMARKS				

# Chemical/Biological Sample Documentation

For use of this form, see FM 3-3; the proponent agency is TRADOC.

## INSTRUCTIONS

Place the biological sample inside a refrigerator, ice chest, or insulated container; and keep it as cool as possible at all times.

Sample Identification Number: \_\_\_\_\_

Date and Time Sample Collected: \_\_\_\_\_

Reason for Collection (check those that apply):

- |   |   |
|---|---|
| <input type="checkbox"/> Chem/Bio Attack                  | <input type="checkbox"/> Chem/Bio Alarm Activated     |
| <input type="checkbox"/> Positive M256 Chemical Detection | <input type="checkbox"/> Positive Recon Team Findings |
| <input type="checkbox"/> Soldiers Becoming Sick           | <input type="checkbox"/> Soldiers Dying               |
| <input type="checkbox"/> Other _____                      |   |

Location of Attack \_\_\_\_\_  
(UTM or place)

Date and Time of Attack \_\_\_\_\_

Unit Identification \_\_\_\_\_  
(Co, Bn, Bde, Div, Corps)

Terrain Description (check those that apply):

- |                                |                                 |  |                                      |                                 |                                 |
|--------------------------------|---------------------------------|--|--------------------------------------|---------------------------------|---------------------------------|
| <input type="checkbox"/> Flat  | <input type="checkbox"/> Hills  | <input type="checkbox"/> Mountains           | <input type="checkbox"/> Desert      | <input type="checkbox"/> Jungle | <input type="checkbox"/> Forest |
| <input type="checkbox"/> Urban | <input type="checkbox"/> Grassy | <input type="checkbox"/> Sparse Trees/Shrubs | <input type="checkbox"/> Other _____ |                                 |                                 |

Weather (check those that apply):

- |                                      |                                 |                               |                              |                               |                               |                               |
|--------------------------------------|---------------------------------|-------------------------------|------------------------------|-------------------------------|-------------------------------|-------------------------------|
| <input type="checkbox"/> Clear       | <input type="checkbox"/> Cloudy | <input type="checkbox"/> Rain | <input type="checkbox"/> Fog | <input type="checkbox"/> Snow | <input type="checkbox"/> Dust | <input type="checkbox"/> Mist |
| <input type="checkbox"/> Other _____ |                                 |                               |                              |                               |                               |                               |

Wind at Collection Site (check only one):

- |                                    |                                      |                                |                                |
|------------------------------------|--------------------------------------|--------------------------------|--------------------------------|
| <input type="checkbox"/> None/Calm | <input type="checkbox"/> Mild Breeze | <input type="checkbox"/> Windy | <input type="checkbox"/> Gusts |
|------------------------------------|--------------------------------------|--------------------------------|--------------------------------|

Odor (check those that apply):

- |                                   |                                      |                                 |                                     |                                 |                                 |
|-----------------------------------|--------------------------------------|---------------------------------|-------------------------------------|---------------------------------|---------------------------------|
| <input type="checkbox"/> None     | <input type="checkbox"/> Sweet       | <input type="checkbox"/> Fruity | <input type="checkbox"/> Irritating | <input type="checkbox"/> Pepper | <input type="checkbox"/> Flower |
| <input type="checkbox"/> Changing | <input type="checkbox"/> Other _____ |                                 |                                     |                                 |                                 |

Symptoms (check those that apply):

- |                                    |   |   |   |
|------------------------------------|---|---|---|
| <input type="checkbox"/> None      | <input type="checkbox"/> Skin Swelling      | <input type="checkbox"/> Difficulty Breathing | <input type="checkbox"/> Blurred Vision |
| <input type="checkbox"/> Dizziness | <input type="checkbox"/> Skin Rash          | <input type="checkbox"/> Nausea               | <input type="checkbox"/> Dry Mouth      |
| <input type="checkbox"/> Fever     | <input type="checkbox"/> Dark Skin Blotches | <input type="checkbox"/> Unconscious          |   |
| <input type="checkbox"/> Headache  | <input type="checkbox"/> Bleeding Sores     | <input type="checkbox"/> Other _____          |   |

Symptoms:

Time of Onset: \_\_\_\_\_

Duration (of Symptoms): \_\_\_\_\_



**Delivery Method** (check those that apply):

- Unknown    Artillery    Mortar    RPG/Grenade    Rocket  
 Aircraft    Aerosol    Generator    Other \_\_\_\_\_

**State of Agent at Time of Collection** (check only one):

- Liquid    Vapor    Powder    Solid    Smoke    Mist  
 Dust (cloud)    Gel    Other \_\_\_\_\_

**Description of Sample** (check only one):

- Vegetation    Soil    Other \_\_\_\_\_
- Biomedical:    Urine    Blood    Tissue

Color of Sample \_\_\_\_\_

Size of Sample \_\_\_\_\_

Other \_\_\_\_\_

**Additional Remarks:**

## NBC 1 Observer's Initial or Follow-Up Report

For use of this form, see FM 3-3; the proponent agency is TRADOC.

From	To
Precedence <input type="checkbox"/> FLASH <input type="checkbox"/> IMMEDIATE	Security Classification
Date-Time (Zulu, Local, or Letter Time Zone)	
Type of Report <input type="checkbox"/> Chemical <input type="checkbox"/> Nuclear <input type="checkbox"/> Biological	Category of Report <input type="checkbox"/> Initial <input type="checkbox"/> Follow-Up

### Instructions

1. Line items DELTA and HOTEL are mandatory for NBC 1 reports.
2. Line items ALFA, ECHO, GOLF, INDIA, KILO, LIMA, MIKE, SIERRA, YANKEE, and ZULU ALFA are optional for NBC 1 reports.
3. Line items BRAVO, CHARLIE, FOXTROT, PAPA ALFA ROMEO, and PAPA BRAVO ROMEO are reported if data is available.

### Section I--Chemical or Biological Only

Description	Line	Data							
Strike Serial Number, if known (assigned by NBCE)	ALFA								
Position of Observer	BRAVO								
Azimuth of Attack from Observer (state degrees or mils)	CHARLIE								
Date and Time Attack Started (Zulu, local, or letter zone)	DELTA								
Time Attack Ended, if known	ECHO								
Location of Attack (UTM or place) (state actual or estimated)	FOXTROT								
Means of Delivery, if known	GOLF								
Type of Agent and Height of Burst, if known	HOTEL								
Type and Number of Munitions or Aircraft (state which)	INDIA								
Description of Terrain (bare, scrubby vegetation, wooded, urban, or unknown)	KILO								
Date and Time Contamination Detected (Zulu, local, or letter zone)	SIERRA								
Representative Downwind Direction, 4 digits (state degrees or mils), Wind Speed, 3 digits (state kmph or knots)	YANKEE								
Temperature (centigrade), 2 digits, Cloud Cover, 1 digit, Significant Weather Phenomena, 1 digit, Air Stability, 1 digit	ZULU ALFA								
Remarks	ZULU BRAVO								

**Section II--Nuclear Only**

Description	Line	Data							
Strike Serial Number (assigned by NBCC)	ALFA								
Date and Time Attack Started (Zule, local, or letter zone)	DELTA								
Location of Attack (UTM or place) (state actual or estimated)	FOXTROT								
Estimated Yield (KT or MT)	NOVEMBER								
Direction of Left and Right Radial Lines (state degrees or mils)	YANKEE								
Effective Wind Speed (3 digits--kmph or knots) Downwind Distance of Zone I (3 digits--km) Cloud Radius (2 digits--km, see Instruction 1)	ZULU								
Remarks	ZULU BRAVO								

## NBC 2 Evaluated Data Report

For use of this form, see FM 3-3; the proponent agency is TRADOC.

From	To
<b>PRECEDENCE</b>  <b>IMMEDIATE</b>	Security Classification

Date-Time (Zulu, Local, or Letter Time Zone)

Type of Report <input type="checkbox"/> Chemical <input type="checkbox"/> Nuclear <input type="checkbox"/> Biological	Category of Report <input type="checkbox"/> Initial <input type="checkbox"/> Follow-Up
---	---

**Instructions**

1. Line items ALFA, DELTA, FOXTROT, HOTEL, and NOVEMBER are mandatory for NBC 2 reports.
2. Line items ECHO, GOLF, INDIA, KILO, YANKEE, and ZULU ALFA are optional for NBC 2 reports.

**Section I--Chemical or Biological Only**

Description	Line	Data							
Strike Serial Number (assigned by NBCE)	ALFA								
Date and Time Attack Started (Zulu, local, or letter zone)	DELTA								
Date and Time Attack Ended (Zulu, local, or letter zone)	ECHO								
Location of Attack (UTM or place)(state actual or estimated)	FOXTROT								
Means of Delivery, if known	GOLF								
Type of Agent and Height of Burst, if known	HOTEL								
Number of Shells in Attack	INDIA								
Description of Terrain (bare, scrubby vegetation, wooded, urban, or unknown)	KILO								
Representative Downwind Direction, (4 digits, degrees or mils, state which), Wind Speed (3 digits, kmph or knots, state which)	YANKEE								
Temperature (Centigrade, 2 digits), Cloud Cover (1 digit), Significant Weather Phenomena (1 digit), Air Stability (1 digit)	ZULU ALFA								
Remarks	ZULU BRAVO								

**Section II--Nuclear Only**

Description	Line	Data							
Strike Serial Number (assigned by NBCE)	ALFA								
Date and Time Attack Started (Zule, local, or letter zone)	DELTA								
Location of Attack (UTM or place) (actual or estimated, state which)	FOXTROT								
Means of Delivery, if known	GOLF								
Type of Burst (air, surface, or unknown, state which)	HOTEL								
Crater Diameter (meters), if known	KILO								
Estimated Yield (KT or MT)	NOVEMBER								
Remarks	ZULU BRAVO								

## NBC 3 Immediate Warning of Predicted Contamination and Hazard Areas

For use of this form, see FM 3-3; the proponent agency is TRADOC.

From	To
Precedence <b>IMMEDIATE</b>	Security Classification
Date-Time (Zulu, Local, or Letter Time Zone)	
Type of Report  <input type="checkbox"/> Nuclear <input type="checkbox"/> Chemical <input type="checkbox"/> Biological	Category of Report  <input type="checkbox"/> Initial <input type="checkbox"/> Follow-Up

### Instructions

1. If effective wind speed is less than 8 kmph, line ZULU of the NBC nuclear report consists of only three digits for the radius of Zone 1.
2. Line items ALFA, DELTA, FOXTROT, HOTEL, PAPA ALFA, and ZULU are mandatory for NBC 3 reports.
3. Line items ECHO, NOVEMBER, PAPA BRAVO, and ZULU ALFA are optional for NBC 3 reports.
4. Line item YANKEE is optional for chemical/biological NBC 3 reports; but, it is reported if available for nuclear NBC 3 reports.

### Section I--Chemical or Biological Only

Description	Line	Data					
Strike Serial Number (assigned by NBCC)	ALFA						
Date and Time Attack Started (Zulu, local, or letter zone)	DELTA						
Date and Time Attack Ended (Zulu, local, or letter zone)	ECHO						
Location of Attack (UTM or place) (actual or estimated, state which)	FOXTROT						
Type of Agent	HOTEL						
Coordinates of Predicted Hazard Area (if contours complete, or a complete circle, record the first grid coordinate as the first and the last coordinate)	PAPA ALFA						
Duration of Hazard (in days, hours, min., etc.)	PAPA BRAVO						
Downwind Direction of Hazard and Wind Speed (4 digits)	YANKEE						
Significant Weather Phenomena (see CDM for codes)	ZULU ALFA						
Remarks	ZULU BRAVO						

**Section II--Nuclear Only**

Description	Line	Data							
Strike Serial Number Causing Contamination	ALFA								
Date and Time Attack Started (Zulu, local, or letter zone)	DELTA								
Location of Ground Zero	FOXTROT								
Reference DTG of Estimated Contours When Not at H + 1	OSCAR								
Level of Radiation in cGyph, Dose Rate Trend, Actual Radiation Decay Rate/Relative Radiation Decay Rate	ROMEO								
H + 1 Date and Time (Zulu, local, or letter zone)	TANGO								
1,000-cGyph Countour Line Coordinates (UTM) (coded red on overlay)	UNIFORM								
300-cGyph Countour Line Coordinates (UTM) ( coded green on overlay)	VICTOR								
100-cGyph Countour Line Coordinates (UTM) (coded blue on overlay)	WHISKEY								
20-cGyph Countour Line Coordinates (UTM) (coded black on overlay)	XRAY								
Remarks	ZULU BRAVO								

# NBC 4 Radiation Dose Rate Measurements or Chemical/Biological Areas of Contamination

For use of this form, see FM 3-3; the proponent agency is TRADOC.

From	To
------	----

Precedence <b>IMMEDIATE</b>	Security Classification
--------------------------------	-------------------------

Date-Time (Zulu, Local, or Letter Time Zone)

Type of Report  <input type="checkbox"/> Chemical <input type="checkbox"/> Nuclear <input type="checkbox"/> Biological	Category of Report  <input type="checkbox"/> Initial <input type="checkbox"/> Follow-Up
--	---

### Instructions

1. Line items QUEBEC, ROMEO, and SIERRA may be repeated as often as necessary.
2. Line items HOTEL, QUEBEC, ROMEO, and SIERRA are mandatory for NBC 4 reports.
3. Line items ALFA and KILO are optional for NBC 4 reports.

### Section I--Chemical or Biological Only

Description	Line	Data					
Strike Serial Number (assigned by NBCC)	ALFA						
Type of Agent	HOTEL						
Description of Terrain (bare, scrubby vegetation, wooded, urban, unknown)	KILO						
Location of Reading (UTM) (state whether test was air or liquid)	QUEBEC						
Date and Time of Reading (Zulu, local, or letter zone)	SIERRA						
Type of Agent	HOTEL						
Description of Terrain (bare, scrubby vegetation, wooded, urban, unknown)	KILO						
Location of Reading (UTM) (state whether test was air or liquid)	QUEBEC						
Date and Time of Reading (Zulu, local, or letter zone)	SIERRA						
Type of Agent	HOTEL						
Description of Terrain (bare, scrubby vegetation, wooded, urban, unknown)	KILO						
Location of Reading (UTM) (state whether test was air or liquid)	QUEBEC						
Date and Time of Reading (Zulu, local, or letter zone)	SIERRA						
Remarks	ZULU BRAVO						



**Section II--Nuclear Only**

Description	Line	Data							
Strike Serial Number (assigned by NBCC)	ALFA								
Crater Diameter (meters) if known	KILO								
Location of Reading (UTM)	QUEBEC								
Dose Rate (cGyph) (the words "Initial," "Peak," "Increasing," or "Decreasing" may be added)	ROMEO								
Date and Time of Reading (Zulu, local, or letter zone)	SIERRA								
Location of Reading (UTM)	QUEBEC								
Dose Rate (cGyph) (the words "Initial," "Peak," "Increasing," or "Decreasing" may be added)	ROMEO								
Date and Time of Reading (Zulu, local, or letter zone)	SIERRA								
Location of Reading (UTM)	QUEBEC								
Dose Rate (cGyph) (the words "Initial," "Peak," "Increasing," or "Decreasing" may be added)	ROMEO								
Date and Time of Reading (Zulu, local, or letter zone)	SIERRA								
Remarks	ZULU BRAVO								

## NBC 5 Contamination Area Report

For use of this form, see FM 3-3; the proponent agency is TRADOC.

From	To
Precedence <b style="text-align: center;">IMMEDIATE</b>	Security Classification
Date-Time (Zulu, Local, or Letter Time Zone)	
Type of Report  <input type="checkbox"/> Chemical <input type="checkbox"/> Nuclear <input type="checkbox"/> Biological	Category of Report  <input type="checkbox"/> Initial <input type="checkbox"/> Follow-Up

### Instructions

1. Line items HOTEL, TANGO, and XRAY are mandatory for chemical/biological NBC 5 reports.
2. Line item TANGO is reported if available for nuclear NBC 5 reports.
3. Line item XRAY is optional for nuclear NBC 5 reports.
4. Line items ALFA, DELTA, FOXTROT, ROMEO, SIERRA, UNIFORM, VICTOR, and, WHISKEY are optional for NBC 5 reports.
5. When a countour closes to form a completed ring, the first coordinate is repeated.
6. When requested, decay rates are to be transmitted according to line item ROMEO.

### Section I--Chemical or Biological Only

Description	Line	Data
Strike Serial Number(s) Causing Contamination	ALFA	
Date and Time Attack Started (Zulu, local, or letter zone)	DELTA	
Type of Agent; Height of Burst	HOTEL	
Date and Time Contamination Initially Detected (Zulu, local, or letter zone)	SIERRA	
Date and Time of Latest Survey of Contamination in the Area (Zulu, local, or letter zone)	TANGO	
Area of Tactical Significance of Toxic Contamination (UTM) (coded yellow on overlay)	XRAY	
Remarks	ZULU BRAVO	

**Section II--Nuclear Only**

Section II--Nuclear Only									
Description	Line	Data							
Strike Serial Number, if known (assigned by NBCE)	ALFA								
Position of Observer	BRAVO								
Azimuth of Attack from Observer (state degrees or mils and grid or magnetic)	CHARLIE								
Date and Time attack started (Zulu, local, or letter Zone)	DELTA								
Location of Attack (UTM or place) (state actual or estimated)	FOXTROT								
Means of Delivery, if known	GOLF								
Type of Burst (state air, surface, or unknown)	HOTEL								
Flash-to-Bang Time (seconds)	JULIET								
Crater Diameter (meters), if known	KILO								
Cloud Width at H + 5 Minutes (degrees or mils)	LIMA								
Cloud Angle (top or bottom) or Cloud Height (top or bottom) at H + 10 Minutes (state degrees, mils, meters, or feet)	MIKE								
Location of Radioactive Cloud Outline (UTM)	PAPA ALFA ROMEO								
Downwind Direction of Radioactive Cloud (state degrees or mils)	PAPA BRAVO ROMEO								
Remarks	ZULU BRAVO								

## NBC 6 Detailed Information of Chemical or Biological Attack(s)

For use of this form, see FM 3-3; the proponent agency is TRADOC.

From	To
Precedence <b style="text-align: center;">IMMEDIATE</b>	Security Classification
Date-Time (Zulu, Local, or Letter Time Zone)	
Type of Report  <input type="checkbox"/> Chemical <input type="checkbox"/> Biological	Category of Report  <input type="checkbox"/> Initial <input type="checkbox"/> Follow-Up

### Instructions

1. Prepare this report to accompany chemical/biological samples sent for analysis or upon request.
2. Complete report in narrative form, giving as much detailed information as possible for each line item.

Description	Line	Data
Strike Serial Number (assigned by NBCC)	ALFA	
Date and Time Attack Started (Zulu, local, or letter zone)	DELTA	
Date and Time Attack Ended (Zulu, local, or letter zone)	ECHO	
Area Attacked (location, UTM, or place) (state actual or estimated)	FOXTROT	
Means of Delivery, if known	GOLF	
Type of Agent and Height of Burst, if known	HOTEL	
Number of Munitions or Aircraft	INDIA	
Description of Terrain/Vegetation	KILO	
Location (UTM) and Type of Sample(s)	QUEBEC	
Date and Time Contamination Initially Detected (Zulu, local, or letter zone)	SIERRA	
Date and Time of Latest Survey of Contamination (Zulu, local, or letter zone)	TANGO	
Area of Measured Chemical Contamination (UTM) (coded yellow on overlay)	XRAY	
Downwind Direction (state degrees or miles ) and Wind Speed (kmph)	YANKEE	

Continued on reverse

Remarks

ZULU BRAVO

<b>CHEMICAL DATA SHEET — MONITORING OR SURVEY</b>		DATE	PAGE NO.	NO. OF PAGES
<i>For use of this form, see FM 3-3; proponent of this form is TRADOC.</i>				
UNIT	MONITOR OR SURVEY TEAM MEMBER (Print Name)			
MONITOR OR SURVEY TEAM NUMBER				
MAP USED				
LOCATION/TIME OF TEST OR INDICATION	TYPE DETECTOR USED			AGENT DETECTED
	PAPER	ALARM	KIT	
REMARKS				

# Chemical/Biological Sample Documentation

For use of this form, see FM 3-3; the proponent agency is TRADOC.

## INSTRUCTIONS

Place the biological sample inside a refrigerator, ice chest, or insulated container; and keep it as cool as possible at all times.

Sample Identification Number: \_\_\_\_\_

Date and Time Sample Collected: \_\_\_\_\_

Reason for Collection (check those that apply):

- |   |   |
|---|---|
| <input type="checkbox"/> Chem/Bio Attack                  | <input type="checkbox"/> Chem/Bio Alarm Activated     |
| <input type="checkbox"/> Positive M256 Chemical Detection | <input type="checkbox"/> Positive Recon Team Findings |
| <input type="checkbox"/> Soldiers Becoming Sick           | <input type="checkbox"/> Soldiers Dying               |
| <input type="checkbox"/> Other _____                      |   |

Location of Attack \_\_\_\_\_  
(UTM or place)

Date and Time of Attack \_\_\_\_\_

Unit Identification \_\_\_\_\_  
(Co, Bn, Bde, Div, Corps)

Terrain Description (check those that apply):

- |                                |                                 |  |                                      |                                 |                                 |
|--------------------------------|---------------------------------|--|--------------------------------------|---------------------------------|---------------------------------|
| <input type="checkbox"/> Flat  | <input type="checkbox"/> Hills  | <input type="checkbox"/> Mountains           | <input type="checkbox"/> Desert      | <input type="checkbox"/> Jungle | <input type="checkbox"/> Forest |
| <input type="checkbox"/> Urban | <input type="checkbox"/> Grassy | <input type="checkbox"/> Sparse Trees/Shrubs | <input type="checkbox"/> Other _____ |                                 |                                 |

Weather (check those that apply):

- |                                      |                                 |                               |                              |                               |                               |                               |
|--------------------------------------|---------------------------------|-------------------------------|------------------------------|-------------------------------|-------------------------------|-------------------------------|
| <input type="checkbox"/> Clear       | <input type="checkbox"/> Cloudy | <input type="checkbox"/> Rain | <input type="checkbox"/> Fog | <input type="checkbox"/> Snow | <input type="checkbox"/> Dust | <input type="checkbox"/> Mist |
| <input type="checkbox"/> Other _____ |                                 |                               |                              |                               |                               |                               |

Wind at Collection Site (check only one):

- |                                    |                                      |                                |                                |
|------------------------------------|--------------------------------------|--------------------------------|--------------------------------|
| <input type="checkbox"/> None/Calm | <input type="checkbox"/> Mild Breeze | <input type="checkbox"/> Windy | <input type="checkbox"/> Gusts |
|------------------------------------|--------------------------------------|--------------------------------|--------------------------------|

Odor (check those that apply):

- |                                   |                                      |                                 |                                     |                                 |                                 |
|-----------------------------------|--------------------------------------|---------------------------------|-------------------------------------|---------------------------------|---------------------------------|
| <input type="checkbox"/> None     | <input type="checkbox"/> Sweet       | <input type="checkbox"/> Fruity | <input type="checkbox"/> Irritating | <input type="checkbox"/> Pepper | <input type="checkbox"/> Flower |
| <input type="checkbox"/> Changing | <input type="checkbox"/> Other _____ |                                 |                                     |                                 |                                 |

Symptoms (check those that apply):

- |                                    |   |   |   |
|------------------------------------|---|---|---|
| <input type="checkbox"/> None      | <input type="checkbox"/> Skin Swelling      | <input type="checkbox"/> Difficulty Breathing | <input type="checkbox"/> Blurred Vision |
| <input type="checkbox"/> Dizziness | <input type="checkbox"/> Skin Rash          | <input type="checkbox"/> Nausea               | <input type="checkbox"/> Dry Mouth      |
| <input type="checkbox"/> Fever     | <input type="checkbox"/> Dark Skin Blotches | <input type="checkbox"/> Unconscious          |   |
| <input type="checkbox"/> Headache  | <input type="checkbox"/> Bleeding Sores     | <input type="checkbox"/> Other _____          |   |

Symptoms:

Time of Onset: \_\_\_\_\_

Duration (of Symptoms): \_\_\_\_\_





## NBC 1 Observer's Initial or Follow-Up Report

For use of this form, see FM 3-3; the proponent agency is TRADOC.

From	To
Precedence <input type="checkbox"/> FLASH <input type="checkbox"/> IMMEDIATE	Security Classification
Date-Time (Zulu, Local, or Letter Time Zone)	
Type of Report <input type="checkbox"/> Chemical <input type="checkbox"/> Nuclear <input type="checkbox"/> Biological	Category of Report <input type="checkbox"/> Initial <input type="checkbox"/> Follow-Up

### Instructions

1. Line items DELTA and HOTEL are mandatory for NBC 1 reports.
2. Line items ALFA, ECHO, GOLF, INDIA, KILO, LIMA, MIKE, SIERRA, YANKEE, and ZULU ALFA are optional for NBC 1 reports.
3. Line items BRAVO, CHARLIE, FOXTROT, PAPA ALFA ROMEO, and PAPA BRAVO ROMEO are reported if data is available.

### Section I--Chemical or Biological Only

Description	Line	Data					
Strike Serial Number, if known (assigned by NBCE)	ALFA						
Position of Observer	BRAVO						
Azimuth of Attack from Observer (state degrees or mils)	CHARLIE						
Date and Time Attack Started (Zulu, local, or letter zone)	DELTA						
Time Attack Ended, if known	ECHO						
Location of Attack (UTM or place) (state actual or estimated)	FOXTROT						
Means of Delivery, if known	GOLF						
Type of Agent and Height of Burst, if known	HOTEL						
Type and Number of Munitions or Aircraft (state which)	INDIA						
Description of Terrain (bare, scrubby vegetation, wooded, urban, or unknown)	KILO						
Date and Time Contamination Detected (Zulu, local, or letter zone)	SIERRA						
Representative Downwind Direction, 4 digits (state degrees or mils), Wind Speed, 3 digits (state kmph or knots)	YANKEE						
Temperature (centigrade), 2 digits, Cloud Cover, 1 digit, Significant Weather Phenomena, 1 digit, Air Stability, 1 digit	ZULU ALFA						
Remarks	ZULU BRAVO						

**Section II--Nuclear Only**

Description	Line	Data							
Strike Serial Number (assigned by NBCC)	ALFA								
Date and Time Attack Started (Zule, local, or letter zone)	DELTA								
Location of Attack (UTM or place) (state actual or estimated)	FOXTROT								
Estimated Yield (KT or MT)	NOVEMBER								
Direction of Left and Right Radial Lines (state degrees or mils)	YANKEE								
Effective Wind Speed (3 digits--kmph or knots) Downwind Distance of Zone I (3 digits--km) Cloud Radius (2 digits--km, see Instruction 1)	ZULU								
Remarks	ZULU BRAVO								

## NBC 2 Evaluated Data Report

For use of this form, see FM 3-3; the proponent agency is TRADOC.

From	To
<b>PRECEDENCE</b>  <b>IMMEDIATE</b>	Security Classification

Date-Time (Zulu, Local, or Letter Time Zone)

Type of Report <input type="checkbox"/> Chemical <input type="checkbox"/> Nuclear <input type="checkbox"/> Biological	Category of Report <input type="checkbox"/> Initial <input type="checkbox"/> Follow-Up
---	---

**Instructions**

1. Line items ALFA, DELTA, FOXTROT, HOTEL, and NOVEMBER are mandatory for NBC 2 reports.
2. Line items ECHO, GOLF, INDIA, KILO, YANKEE, and ZULU ALFA are optional for NBC 2 reports.

**Section I--Chemical or Biological Only**

Description	Line	Data							
Strike Serial Number (assigned by NBCE)	ALFA								
Date and Time Attack Started (Zulu, local, or letter zone)	DELTA								
Date and Time Attack Ended (Zulu, local, or letter zone)	ECHO								
Location of Attack (UTM or place)(state actual or estimated)	FOXTROT								
Means of Delivery, if known	GOLF								
Type of Agent and Height of Burst, if known	HOTEL								
Number of Shells in Attack	INDIA								
Description of Terrain (bare, scrubby vegetation, wooded, urban, or unknown)	KILO								
Representative Downwind Direction, (4 digits, degrees or mils, state which), Wind Speed (3 digits, kmph or knots, state which)	YANKEE								
Temperature (Centigrade, 2 digits), Cloud Cover (1 digit), Significant Weather Phenomena (1 digit), Air Stability (1 digit)	ZULU ALFA								
Remarks	ZULU BRAVO								

**Section II--Nuclear Only**

Description	Line	Data							
Strike Serial Number (assigned by NBCE)	ALFA								
Date and Time Attack Started (Zule, local, or letter zone)	DELTA								
Location of Attack (UTM or place) (actual or estimated, state which)	FOXTROT								
Means of Delivery, if known	GOLF								
Type of Burst (air, surface, or unknown, state which)	HOTEL								
Crater Diameter (meters), if known	KILO								
Estimated Yield (KT or MT)	NOVEMBER								
Remarks	ZULU BRAVO								

## NBC 3 Immediate Warning of Predicted Contamination and Hazard Areas

For use of this form, see FM 3-3; the proponent agency is TRADOC.

From	To
Precedence <b>IMMEDIATE</b>	Security Classification
Date-Time (Zulu, Local, or Letter Time Zone)	
Type of Report  <input type="checkbox"/> Nuclear <input type="checkbox"/> Chemical <input type="checkbox"/> Biological	Category of Report  <input type="checkbox"/> Initial <input type="checkbox"/> Follow-Up

### Instructions

1. If effective wind speed is less than 8 kmph, line ZULU of the NBC nuclear report consists of only three digits for the radius of Zone 1.
2. Line items ALFA, DELTA, FOXTROT, HOTEL, PAPA ALFA, and ZULU are mandatory for NBC 3 reports.
3. Line items ECHO, NOVEMBER, PAPA BRAVO, and ZULU ALFA are optional for NBC 3 reports.
4. Line item YANKEE is optional for chemical/biological NBC 3 reports; but, it is reported if available for nuclear NBC 3 reports.

### Section I--Chemical or Biological Only

Description	Line	Data					
Strike Serial Number (assigned by NBCC)	ALFA						
Date and Time Attack Started (Zulu, local, or letter zone)	DELTA						
Date and Time Attack Ended (Zulu, local, or letter zone)	ECHO						
Location of Attack (UTM or place) (actual or estimated, state which)	FOXTROT						
Type of Agent	HOTEL						
Coordinates of Predicted Hazard Area (if contours complete, or a complete circle, record the first grid coordinate as the first and the last coordinate)	PAPA ALFA						
Duration of Hazard (in days, hours, min., etc.)	PAPA BRAVO						
Downwind Direction of Hazard and Wind Speed (4 digits)	YANKEE						
Significant Weather Phenomena (see CDM for codes)	ZULU ALFA						
Remarks	ZULU BRAVO						

**Section II--Nuclear Only**

Description	Line	Data							
Strike Serial Number Causing Contamination	ALFA								
Date and Time Attack Started (Zulu, local, or letter zone)	DELTA								
Location of Ground Zero	FOXTROT								
Reference DTG of Estimated Contours When Not at H + 1	OSCAR								
Level of Radiation in cGyph, Dose Rate Trend, Actual Radiation Decay Rate/Relative Radiation Decay Rate	ROMEO								
H + 1 Date and Time (Zulu, local, or letter zone)	TANGO								
1,000-cGyph Countour Line Coordinates (UTM) (coded red on overlay)	UNIFORM								
300-cGyph Countour Line Coordinates (UTM) ( coded green on overlay)	VICTOR								
100-cGyph Countour Line Coordinates (UTM) (coded blue on overlay)	WHISKEY								
20-cGyph Countour Line Coordinates (UTM) (coded black on overlay)	XRAY								
Remarks	ZULU BRAVO								

# NBC 4 Radiation Dose Rate Measurements or Chemical/Biological Areas of Contamination

For use of this form, see FM 3-3; the proponent agency is TRADOC.

From	To
------	----

Precedence <b>IMMEDIATE</b>	Security Classification
--------------------------------	-------------------------

Date-Time (Zulu, Local, or Letter Time Zone)

Type of Report <input type="checkbox"/> Chemical <input type="checkbox"/> Nuclear <input type="checkbox"/> Biological	Category of Report <input type="checkbox"/> Initial <input type="checkbox"/> Follow-Up
--	---

### Instructions

1. Line items QUEBEC, ROMEO, and SIERRA may be repeated as often as necessary.
2. Line items HOTEL, QUEBEC, ROMEO, and SIERRA are mandatory for NBC 4 reports.
3. Line items ALFA and KILO are optional for NBC 4 reports.

### Section I--Chemical or Biological Only

Description	Line	Data					
Strike Serial Number (assigned by NBCC)	ALFA						
Type of Agent	HOTEL						
Description of Terrain (bare, scrubby vegetation, wooded, urban, unknown)	KILO						
Location of Reading (UTM) (state whether test was air or liquid)	QUEBEC						
Date and Time of Reading (Zulu, local, or letter zone)	SIERRA						
Type of Agent	HOTEL						
Description of Terrain (bare, scrubby vegetation, wooded, urban, unknown)	KILO						
Location of Reading (UTM) (state whether test was air or liquid)	QUEBEC						
Date and Time of Reading (Zulu, local, or letter zone)	SIERRA						
Type of Agent	HOTEL						
Description of Terrain (bare, scrubby vegetation, wooded, urban, unknown)	KILO						
Location of Reading (UTM) (state whether test was air or liquid)	QUEBEC						
Date and Time of Reading (Zulu, local, or letter zone)	SIERRA						
Remarks	ZULU BRAVO						

**Section II--Nuclear Only**

Description	Line	Data							
Strike Serial Number (assigned by NBCC)	ALFA								
Crater Diameter (meters) if known	KILO								
Location of Reading (UTM)	QUEBEC								
Dose Rate (cGyph) (the words "Initial," "Peak," "Increasing," or "Decreasing" may be added)	ROMEO								
Date and Time of Reading (Zulu, local, or letter zone)	SIERRA								
Location of Reading (UTM)	QUEBEC								
Dose Rate (cGyph) (the words "Initial," "Peak," "Increasing," or "Decreasing" may be added)	ROMEO								
Date and Time of Reading (Zulu, local, or letter zone)	SIERRA								
Location of Reading (UTM)	QUEBEC								
Dose Rate (cGyph) (the words "Initial," "Peak," "Increasing," or "Decreasing" may be added)	ROMEO								
Date and Time of Reading (Zulu, local, or letter zone)	SIERRA								
Remarks	ZULU BRAVO								



## NBC 5 Contamination Area Report

For use of this form, see FM 3-3; the proponent agency is TRADOC.

From	To
------	----

Precedence <b>IMMEDIATE</b>	Security Classification
--------------------------------	-------------------------

Date-Time (Zulu, Local, or Letter Time Zone)

Type of Report <input type="checkbox"/> Chemical <input type="checkbox"/> Nuclear <input type="checkbox"/> Biological	Category of Report <input type="checkbox"/> Initial <input type="checkbox"/> Follow-Up
--	---

### Instructions

1. Line items HOTEL, TANGO, and XRAY are mandatory for chemical/biological NBC 5 reports.
2. Line item TANGO is reported if available for nuclear NBC 5 reports.
3. Line item XRAY is optional for nuclear NBC 5 reports.
4. Line items ALFA, DELTA, FOXTROT, ROMEO, SIERRA, UNIFORM, VICTOR, and, WHISKEY are optional for NBC 5 reports.
5. When a countour closes to form a completed ring, the first coordinate is repeated.
6. When requested, decay rates are to be transmitted according to line item ROMEO.

### Section I--Chemical or Biological Only

Description	Line	Data
Strike Serial Number(s) Causing Contamination	ALFA	
Date and Time Attack Started (Zulu, local, or letter zone)	DELTA	
Type of Agent; Height of Burst	HOTEL	
Date and Time Contamination Initially Detected (Zulu, local, or letter zone)	SIERRA	
Date and Time of Latest Survey of Contamination in the Area (Zulu, local, or letter zone)	TANGO	
Area of Tactical Significance of Toxic Contamination (UTM) (coded yellow on overlay)	XRAY	
Remarks	ZULU BRAVO	

**Section II--Nuclear Only**

Description		Line	Data						
Strike Serial Number, if known (assigned by NBCE)	ALFA								
Position of Observer	BRAVO								
Azimuth of Attack from Observer (state degrees or mils and grid or magnetic)	CHARLIE								
Date and Time attack started (Zulu, local, or letter Zone)	DELTA								
Location of Attack (UTM or place) (state actual or estimated)	FOXTROT								
Means of Delivery, if known	GOLF								
Type of Burst (state air, surface, or unknown)	HOTEL								
Flash-to-Bang Time (seconds)	JULIET								
Crater Diameter (meters), if known	KILO								
Cloud Width at H + 5 Minutes (degrees or mils)	LIMA								
Cloud Angle (top or bottom) or Cloud Height (top or bottom) at H + 10 Minutes (state degrees, mils, meters, or feet)	MIKE								
Location of Radioactive Cloud Outline (UTM)	PAPA ALFA ROMEO								
Downwind Direction of Radioactive Cloud (state degrees or mils)	PAPA BRAVO ROMEO								
Remarks	ZULU BRAVO								

## NBC 6 Detailed Information of Chemical or Biological Attack(s)

For use of this form, see FM 3-3; the proponent agency is TRADOC.

From	To
Precedence <b style="text-align: center;">IMMEDIATE</b>	Security Classification
Date-Time (Zulu, Local, or Letter Time Zone)	
Type of Report  <input type="checkbox"/> Chemical <input type="checkbox"/> Biological	Category of Report  <input type="checkbox"/> Initial <input type="checkbox"/> Follow-Up

### Instructions

1. Prepare this report to accompany chemical/biological samples sent for analysis or upon request.
2. Complete report in narrative form, giving as much detailed information as possible for each line item.

Description	Line	Data
Strike Serial Number (assigned by NBCC)	ALFA	
Date and Time Attack Started (Zulu, local, or letter zone)	DELTA	
Date and Time Attack Ended (Zulu, local, or letter zone)	ECHO	
Area Attacked (location, UTM, or place) (state actual or estimated)	FOXTROT	
Means of Delivery, if known	GOLF	
Type of Agent and Height of Burst, if known	HOTEL	
Number of Munitions or Aircraft	INDIA	
Description of Terrain/Vegetation	KILO	
Location (UTM) and Type of Sample(s)	QUEBEC	
Date and Time Contamination Initially Detected (Zulu, local, or letter zone)	SIERRA	
Date and Time of Latest Survey of Contamination (Zulu, local, or letter zone)	TANGO	
Area of Measured Chemical Contamination (UTM) (coded yellow on overlay)	XRAY	
Downwind Direction (state degrees or miles ) and Wind Speed (kmph)	YANKEE	

Continued on reverse

Remarks

ZULU BRAVO

# Glossary

## A

**ABCA allies** - American, British, Canadian, and Australian allies

**Active defense measures** - Measures taken to find and destroy either the munitions or the delivery systems of an NBC attack.

**ADA** - Air defense artillery

**APC** - Armored personnel carriers

**Arthropods** - Group of invertebrate animals that have a jointed body and legs such as insects, arachnids, and crustaceans.

**AWS** - Air weather service

## C

**CAT** - Cloud arrival time. Used for biological agent calculations.

**CB** - Chemical/biological

**CDM** - Chemical downwind message

**CET** - Cloud exposure time. Used for biological agent calculations.

**CFA** - Covering force area

**CHEMWARN** - Friendly chemical attack warning

**COMMZ** - Communications zone

## E

**ECM** - Electronic countermeasures

**ECCM** - Electronic counter-countermeasures

**EW** - Electronic warfare

## F

**FDC** - Fire direction centers

**FEBA** - Forward edge of the battle area

**PLOT** - Forward line of troops

**FSE** - Fire support element

**FSOP** - Field standing operating procedures

## G

**GN** - Grid north.

**GMT** - Greenwich Mean Time

**GZ** - Ground zero

## K

**km** - Kilometer

## M

**METT-T** - mission, enemy, terrain, troops, and time

available

**Minimum safe distance** - Distance corresponding to a degree of protection needed to remain in the area.

**MOPP gear** - Protective clothing and equipment worn appropriate to the threat, work rate imposed by the mission, temperature, and humidity.

**MSD** - Minimum safe distance

## N

**NATO** - North Atlantic Treaty Organization

**NAV CDM** - U.S. Naval Chemical Downwind Message

**NBC** - Nuclear, biological and Chemical

**NBCC** - NBC center

**NBCWRS** - NBC warning and reporting system

## O

**OPSEC** - Operational security

**OPORD** - Operational order

**OPLAN** - Operations plan

**OPCON** - Operational control

## P

**Passive defense measures** - Measures taken to reduce possibilities of (or effects of) NBC attack.

**Pathogens** - living microorganisms that cause disease in man, animals, or plants.

**POW** - prisoner of war

## S

**SIGSEC** - Signal security

**SOP** - Standing operating procedures

## T

**TARR** - Time of arrival

**Toxins** - Poisonous substances produced as by-products of microorganisms (the pathogens), plants, and animals.

## U

**Universal transverse mercator** - Meridians and parallels of latitudes appearing lines crossing at right angles.

**USMC** - United States Marine Corps

**USMTF** - United States Message Text Format

**UTM** - Universal transverse mercator

# References

## Related Publications

Related publications are sources of additional information. Users do not have to read them to understand FM 3-3, JCS Publication 25, United States Message Text Format (USMTF) Program.

### Army Regulations (AR)

- 31025 Dictionary of US Army Terms
- 310-50 Catalog of Abbreviations and Brevity Codes
- 350-41 Nuclear, Biological and Chemical Defense and Chemical Warfare

### Field manuals

- 3-3-1 Nuclear Contamination Avoidance
- 3-4 NBC Protection
- 3-5 NBC Decontamination
- 3-6 Field Behavior of Chemical Agents
- 3-7 NBC Handbook
- 3-9 Military Chemistry and Chemical Compounds (AFR 355-7)
- 3-19 NBC Reconnaissance
- 3-50 Deliberate Smoke Operations
- 3-100 NBC Operations
- 6-15 Field Artillery Meteorology
- 7-7 The Mechanized Infantry Platoon and Squad (APC)
- 8-9 NATO Handbook on the Medical Aspects of NBC Defensive Operations (AMED P-6; NAVMED P-5059; AFP 161-3)
- 8-33 Control of Communicable Diseases in Man
- 8-285 Treatment of Chemical Agent Casualties and Conventional Military Chemical Injuries
- 11-50 Combat Communications Within the Division (How to Fight)
- 17-95 Cavalry (How to Fight)
- 20-33 Combat Flame Operations
- 21-60 Visual Signals
- 21-305 Manual for Wheeled Vehicle Driver
- 22-100 Military Leadership
- 23-9 M16A1 Rifle and Rifle Marksmanship
- 23-31 40mm Grenade Launchers M203 and M79
- 23-67 Machinegun, 7.62-mm, M60
- 24-1 Combat Communications
- 24-18 Tactical Single-Channel Radio Communications Techniques
- 27-10 The Law of Land Warfare
- 30-16 Technical Intelligence
- 34-1 Intelligence and Electronic Warfare Operations
- 34-3 Intelligence Analysis
- 71-1 Tank and Mechanized Infantry Company Team (How to Fight)
- 90-2 Tactical Deception (How to Fight)
- 90-3 Desert Operations (How to Fight)
- 90-5 Jungle Operations (How to Fight)
- 90-6 Mountain Operations (How to Fight)
- 90-10 Military Operations on Urbanized Terrain (MOUT) (How to Fight)
- 100-5 Operations (How to Fight)

**101-5 Staff Organization and Procedures****Soldier Training Publications (STP)**

- 3-54B-TG Trainer's Guide for MOS54B, NBC Specialist
- 3-54B1-SM Soldier's Manual for MOS 54B, NBC Specialist (Skill Level 1)
- 3-54B2-SM Soldier's Manual for MOS 54B, NBC Specialist (Skill Level 2)
- 3-54B34-SM-TG Soldier's Manual and Trainer's Guide for MOS 54B, NBC Specialist (Skills Levels 3 and 4)
  
- 21-1 Soldiers Manual of Common Task (Skill Level 1)
- 21-2 Soldiers Manual of Common Task (Skill Levels 2, 3, and 4)

**Department of the Army Forms (DA Forms)**

- 1971-2-R Chemical Data Sheet - Monitoring or Survey

**Miscellaneous Publications**

- ATP 45- Volume II
- TM 3-216 Technical Aspects of Biological Defense

# Index

## A

ABC-M8 Chemical Agent Detector paper, 3-4, 3-80-4  
 Acquisition Reporting, 5-16  
 Admin-Log nets, 2-5  
 aerosol generators, 4-9  
 Air Stability Category, 3-11, 3-17  
 Air Weather Service (AWS), 3-9  
 Air-Contaminating Agents-Type A, 3-12  
 ANBACIS, 2-5  
 Anthrax, A-4  
 Area of Operations/Area of Influence (AO/AI), 1-1  
 Area Surveillance, 5-6  
 Army Training and Evaluation Plan (ARTEP), A-1  
 ATP 45/STANAG 2103, 2-1  
 Automated Nuclear, Biological and Chemical Information System (ANBACIS), 2-3, 2-6  
 Automatic Chemical Agent Alarm (ACAA), 3-1, 5-1  
 Automatic Masking, 1-1

## B

Bacillus Anthracis, B-0  
 Bacteria, B-0  
 Battalion Aid Station (BAS), A-11  
 BDOs, A-3  
 Beginning Morning Nautical Twilight (BMNT), 4-1  
 Belt Weather Kit, 3-9  
 Biological Agent Sampler (XM2), 5-12, A-3  
 Biological Agents, 4-0, 4-5  
   Bacteria, 4-0  
   Pathogens, 4-0  
   Rickettsiae, 4-0  
   Toxins, 4-0  
   Viruses, 4-0  
 Biological Sampling, 5-7  
 Biological Vulnerability Analysis, 1-6  
 Botulinum Toxin, A-4

## C

CAIRA (Chemical Accident/Incident Response and Assistance), 6-0  
 Casualty Estimate, 1-4  
 CB surveys, 1-6  
 CB Threat Status, 1-2  
 Chemical Agent Alarm XM21 (RSCAAL), 3-6  
 Chemical Agent Monitor (CAM), 1-4, 3-1, 3-29, 5-1  
 Chemical Agent Persistence, 1-5  
 Chemical Agents, 3-0  
   blister, 3-0  
   blood, 3-0  
   choking, 3-0

irritants, 3-0  
 nerve, 3-0  
 psychochemical, 3-0  
 chemical defense equipment (CDE), A-1  
 Chemical Downwind Hazard Prediction, 3-12  
 Chemical Downwind Message (CDM), 1-3, 3-8  
 Chemical Hazard Prediction, 3-15, 3-16  
 Chemical Hazard Prediction at Sea, 3-21  
 Chemical Vulnerability Analysis, 1-4  
 CHEMWARN, 2-6, 2-7  
 ciprofloxacin antibiotic tablets, A-4  
 Cloud Duration, A-14  
 Collective Protection Shelters, 1-2  
 collective tasks, A-1  
 Contamination Avoidance, vi  
   Implement Passive Defensive Measures, vi  
   Limit exposure, vi  
   Locate and Identify, Track and Predict NBC Hazards, vi  
   Protection and Decontamination, vi  
   Warn and Report, vi  
 CONUS Labs, 4-19

## D

Decision Support Template (DST), 1-1  
 Decontamination Apparatus (DAP), 1-3  
 dengue Fever, B-0  
 Duration of Agent, 3-12  
 Dusty agents, 3-1

## E

E-MAP, 2-7  
 Eastern Equine Encephalitis, B-0  
 ECCM, 1-6  
 ECM, 1-6  
 encapsulation, 4-1  
 EOD teams, A-15  
 Epidemic, 4-4  
 Evacuation of Biological Samples, 4-19

## F

Fire Support Officer (FSO), 1-1  
 Flame Field Expedients (FFE), 1-2, 2-7  
 Flash precedures, 2-2  
 FLOT, 3-0  
 FOX. XM93, NBC Reconnaissance System (NBCRS), 3-6, 5-1  
 Francisella tularensis, B-6



**G**

Ground-Contaminating Agents-Type B, 3-12

**H**

Heavy liquid contamination, 1-5  
 Helicopter Operations, 3-29  
 Hemorrhagic Fever, B-0  
 Host Nation (HN), 6-0, A-15  
 Host Nation support, 1-15

**I**

IMMEDIATE precedence, 2-2  
 immunizations, 4-7  
 Individual Chemical Agent Detector (ICAD), 3-4  
 Intelligence Preparation of the Battlefield, 1-0  
 Intelligence Summaries (INSUMs), 1-1  
 Intelligence Preparation of the Battlefield (IPB), 1-0

**M**

M11, A-9  
 M13 DAP, A-9  
 M256 Chemical Detector Kit, 2-2, 3-1, 3-5, 3-8  
 M256A1 Chemical Agent Detector Kit, 3-29  
 M272 Water Testing Kit 3-5, 5-1  
 M34 Biological Agent Sampling Kit (CBASK), 4-19,  
 5-1, 5-12, A-3  
 M34 sampling kit, 4-19, 5-1  
 M8A1 Chemical Agent Alarm, 3-29, 5-1  
 M9 Chemical Agent Detector Paper, 3-5, 5-1  
 M93 NBC Reconnaissance Vehicle (FOX), 3-6, 5-1  
 maneuver Control System (MCS), 2-5  
 Mask only, A-5  
 METT-T, 1-7  
 Military Police, A-15  
 Mission Orientated Protective Posture (MOPP), 2-2, 4-4  
 Mission, enemy, terrain, troops, and time available), 1-7  
 Mobile Mass Spectrometer (MMI), 3-6  
 Moderate liquid contamination, 1-5  
 MOPP, 1-2, 1-3, 1-7, 3-0  
 MOPP Analysis, 1-3, 1-5, A-1, A-5  
 Movement Control Center (MCC), 1-7  
 Mustard (HD), 31

**N**

Named Areas of Interest (NAI), 1-1  
 National Command Authority (NCA), 4-19, 5-17  
 NAV CDM, 3-22  
 Naval Chemical Downwind Hazard Prediction, 3-23  
 Naval Detailed Chemical Downwind Hazard Prediction,  
 3-23  
 Navy Forward Laboratory, 4-19  
 NBC 1 Chemical Follow-up Reports, 4-10

NBC 1 report, 2-1, 2-2, 2-4, 4-9  
 NBC 2 report, 2-3  
 NBC 3 report, 2-3, 2-4, 3-19  
 NBC 4 report, 2-3  
 NBC 5 report, 2-3, 5-5  
 NBC 6 report, 2-4, 5-5, 5-6  
 NBC contamination marking equipment, 3-6, 5-5, 5-7  
 NBC protective covers (NBC-PC), 1-7, A-1  
 NBC Reconnaissance System (NBCCRS), A-7  
 NBC Warning and Reporting System (NBCWRS), 4-8  
 NBCC, 1-8, 2-4, 2-6  
 Division NBCC, 2-4  
 NBCWRS, 2-1  
 Nerve Agent Pretreatment (NAP), A-1  
 Nonpersistent, 3-0

**O**

Operational Security (OPSEC), 1-6

**P**

pathogens, 4-8, 4-14  
 Point Surveillance, 5-6  
 Persistent, 3-0  
 persistency of biological agent, 4-3  
 Priority Intelligence Requirements (PIR), 1-0

**Q**

Q Fever, B-0

**R**

Radiac Equipment (ASGI), 3-6  
 Reconnaissance (NBCRS MOUNTED), 5-6  
 relative humidity, 4-1  
 Remote Sensing Chemical Agent Alarm XM21 (RS), 3-  
 Rickettsia SPP (Spotted Fevers), B-0  
 Rickettsiae, B-0  
 Rift Valley fever, B-0  
 Rocky Mountain Spotted Fever B-0

**S**

Salmonella Typhi (Typhoid Fever), B-0  
 SALUTE report, 2-2  
 Sarin (GB), 3-0, 3-1, 3-24, 3-26  
 Simplified hazard Prediction, 3-11  
 SITREP report, 2-2  
 Smallpox, B-0  
 Soman (GD), 3-0, 3-24  
 Special Forces Group (SFG), 2-4  
 Special Forces Operational Detachments (SFOD) 2-4  
 SPOT report, 2-2  
 Staff Weather Officer, 3-8  
 STANAG 2984, 1-2

## FM 3-3

Surveys, 5-2  
Suspected Biological Report, 4-2

### T

Tabun (GA), 3-0  
Tactical Considerations, vii  
    Enemy, vii  
    Mission, vii  
    Terrain, vii  
    Time, vii  
    Training, vii  
    Troops, vii  
Tactical mobility, 1-7  
target Areas of Interest (TAIs), 1-1  
Temperature Gradients, 3-10, 4-2  
    Neutral, 3-10  
    Stable, 3-10  
    Unstable, 3-10  
TOC, 2-5  
Toxicity, B-1  
Toxins, 4-0  
    cytotoxins, 4-0  
    mycotoxins, 4-1  
    neurotoxins, 4-0  
T-2 toxin, B-1  
transient contamination, A-4

### U

US Air Force Weather Service (AWS), 3-8

### V

vectors, 4-8  
Vehicle Orientation System (VOS-25), 3-6  
Venezuelan Equine Encephalitis, B-0  
Vibrio Cholerae (Cholera), B-0

### W

Wind, 4-2  
Wind speed effects, 3-1

### X

XM21 Remote Alarm, 3-7, 5-6

### Y

Yellow Fever, B-0  
Yersinia Pestis (Plague), B-0

By Order of the Secretary of the Army:

Official:

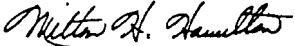
  
MILTON H. HAMILTON  
*Administrative Assistant to the  
Secretary of the Army*  
03147

GORDON R. SULLIVAN  
*General, United States Army  
Chief of Staff*

By Order of the Marine Corps:

RONALD D. ELLIOTT  
EXECUTIVE DIRECTOR  
SYSTEMS COMMAND  
U.S. MARINE CORPS

DISTRIBUTION:

Active Army, USAR, and ARNG: To be distributed in accordance with DA Form 12-IIIE, requirements for FM 3-3, Chemical and Biological Contamination Avoidance (Qty rqr block no. 3829)